



どちらがおおい 2

● はいっているみずが
おおいじゅんばん



日にち： 月 日

名まえ _____

- ・ はいっているみずが おおいじゅんに 1, 2, 3 をかきましょう。(うすいじはなぞりましょう。)

①

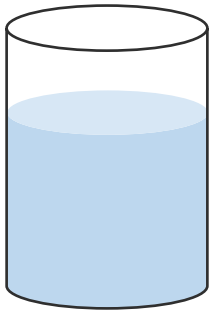

(1)

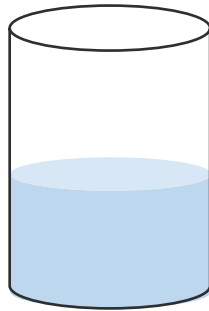

(2)

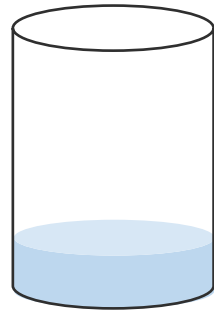

()

②

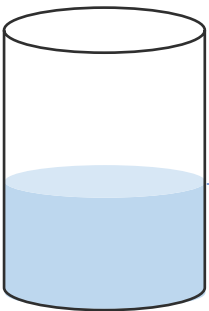

()

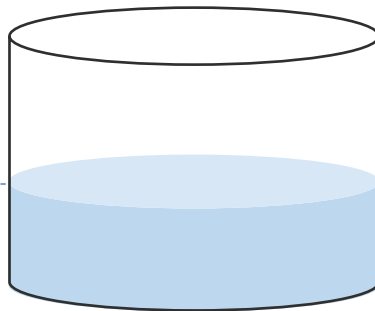

(1)

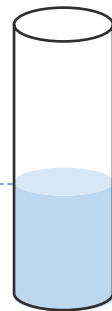

()





どちらがおおい 2

● はいっているみずが
おおいじゅんばん



日にち： 月 日

名まえ _____

- ・ はいっているみずがおおいじゅんに 1, 2, 3をかきましょう。(うすいじはなぞりましょう。)

①

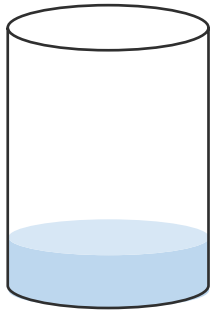

()

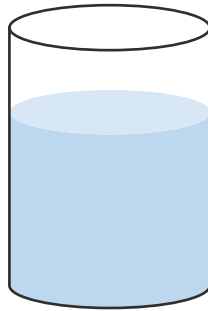

(1)

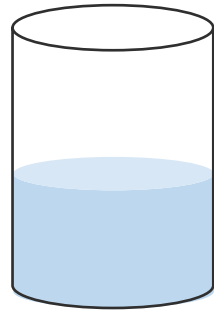

()

②

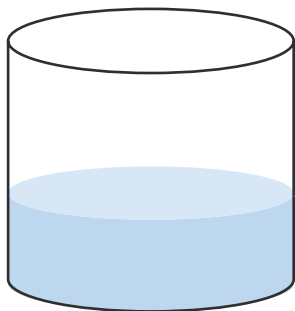

()

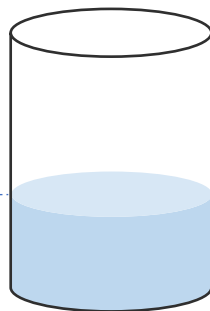

()

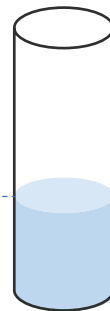

()





どちらがおおい 2

● はいっているみずが
おおいじゅんばん



日にち： 月 日

名まえ _____

- ・ はいっているみずが おおいじゅんに 1, 2, 3 をかきましょう。

①

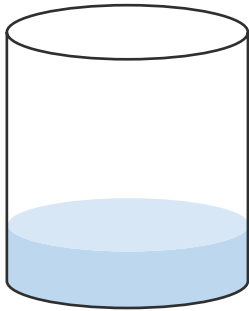

()

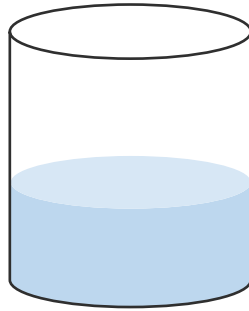

()

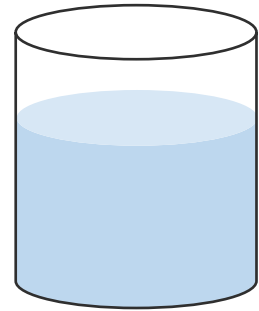

()

②

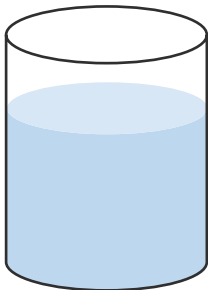

()

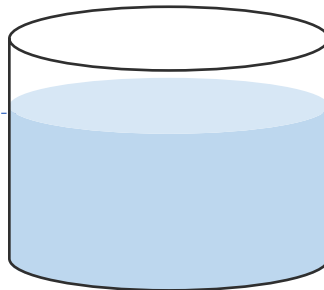

()

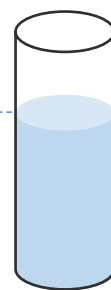

()

③ 確認





どちらがおいしい？

● はいっているみずが
おいしいじゅんばん



日にち： 月 日

名まえ _____

- ・ はいっているみずがおいしいじゅんに 1, 2, 3をかきましょう。

①

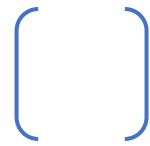
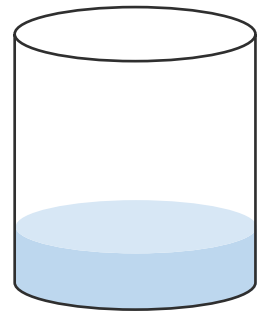
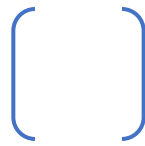
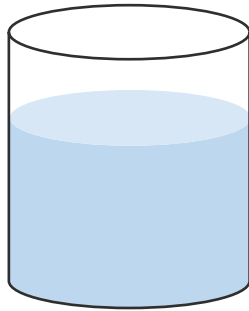
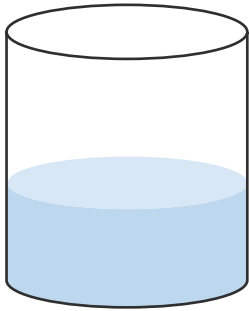

②

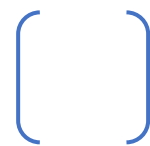
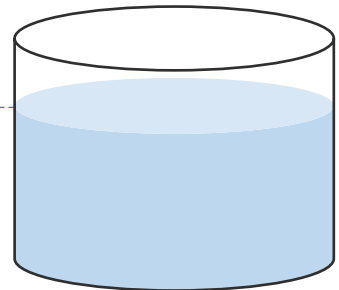
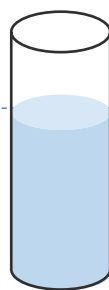
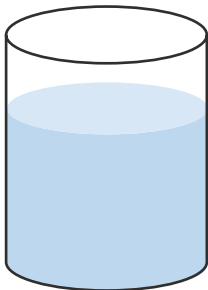



どちらがおおい2

● はいつているみずが
おおいじゅんばん



日にち： 月 日

名まえ _____

- ・ はいつているみずが おおいじゅんばんに 1, 2, 3 をかきましょう。

①

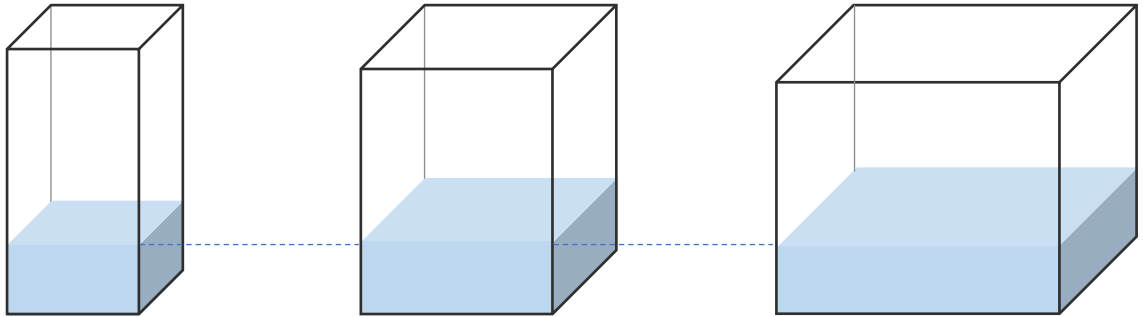

()

()

()

②

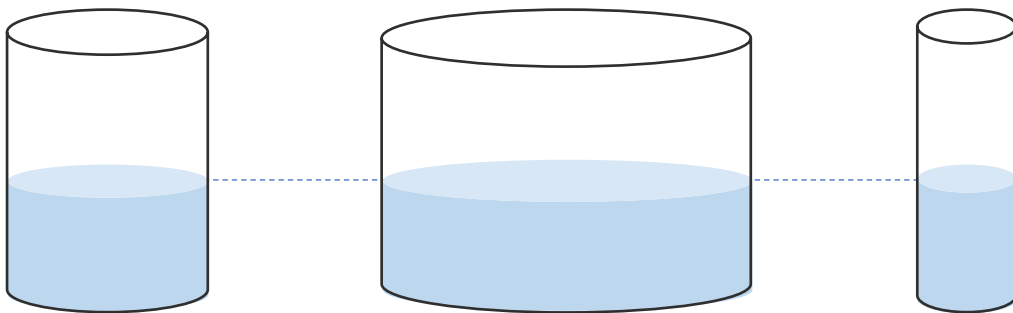

()

()

()





どちらがおおい2

● はいつているみずが
おおいじゅんばん



日にち： 月 日

名まえ _____

- ・ はいつているみずが おおいじゅんばんに 1, 2, 3をかきましょう。

①

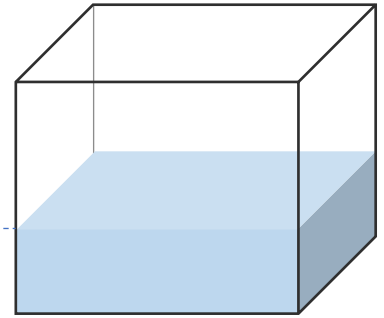
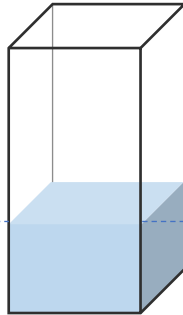
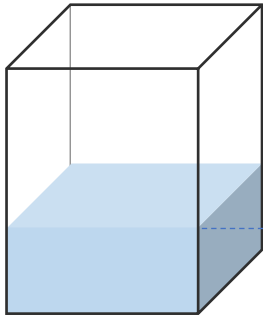

()

()

()

②

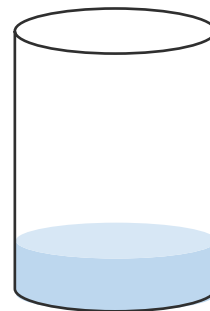
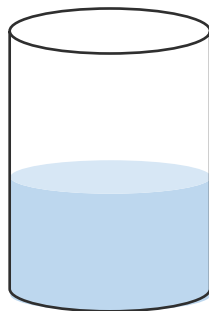
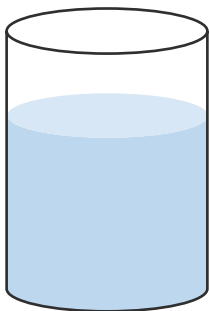

()

()

()





どちらがおおい 2

● はいつているみずが
おおいじゅんばん



日にち： 月 日

名まえ _____

- ・ はいつているみずが おおいじゅんばんに 1, 2, 3 をかきましょう。

①

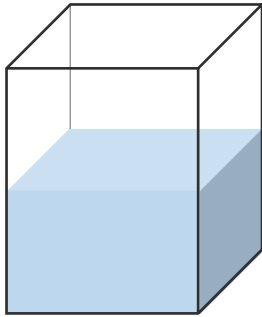

()

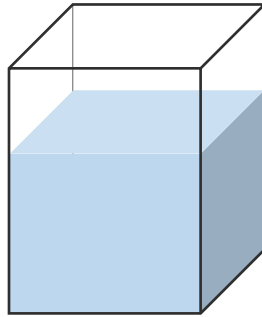

()

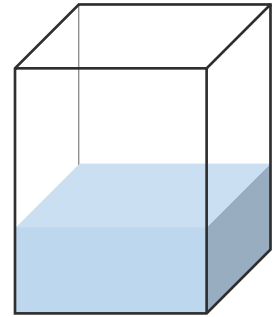

()

②

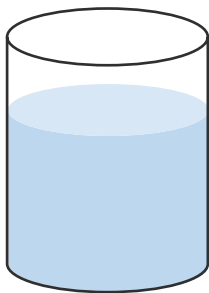

()

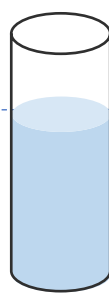

()

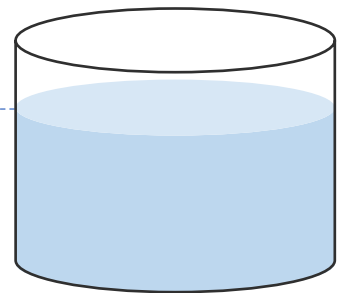

()





どちらがおおい2

● はいつているみずが
おおいじゅんばん



日にち： 月 日

名まえ _____

- ・ はいつているみずが おおいじゅんばんに 1, 2, 3 をかきましょう。

①

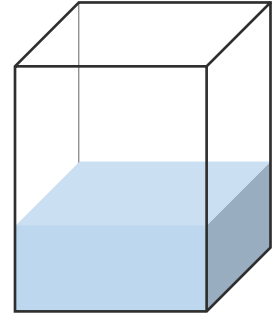
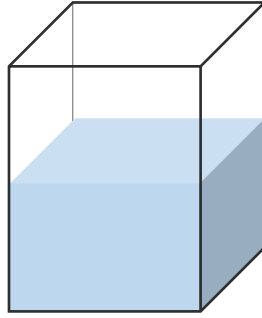
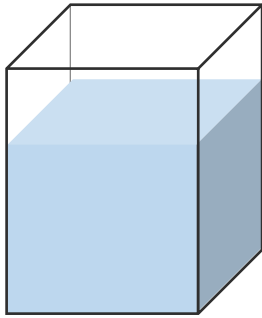

()

()

()

②

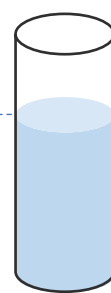
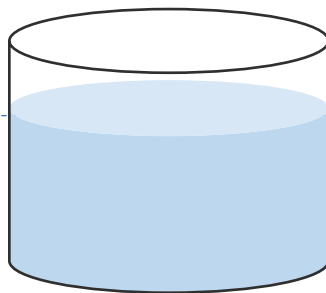
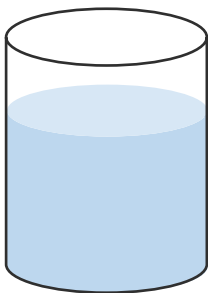

()

()

()





どちらがおおい2

● はいつているみずが
おおいじゅんばん



日にち： 月 日

名まえ _____

- ・ はいつているみずが おおいじゅんばんに 1, 2, 3 をかきましょう。

①

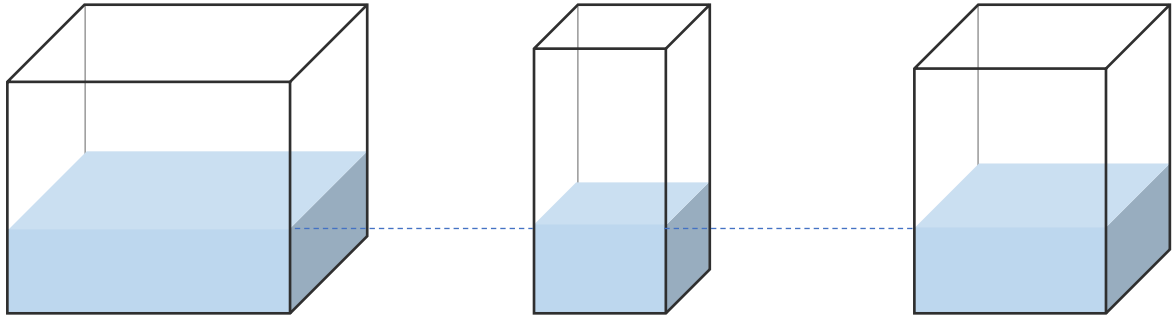

()

()

()

②

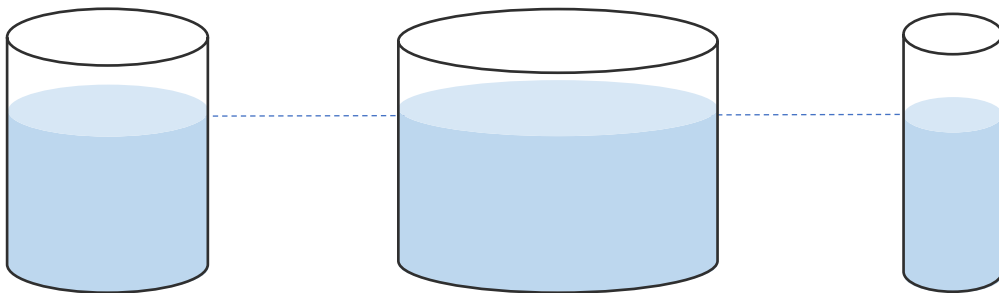

()

()

()





どちらがおおい 2

● はいっているみずが
おおいじゅんばん



日にち： 月 日

名まえ _____

- ・ はいっているみずがおおいじゅんに 1, 2, 3をかきましょう。(うすいじはなぞりましょう。)

①

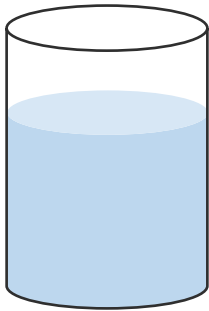

(1)

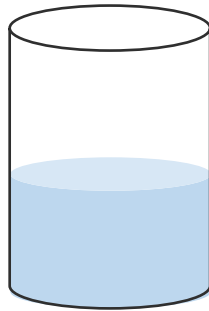

(2)

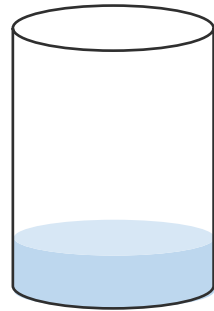

(3)

②

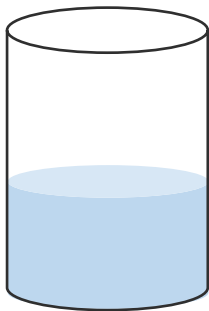

(2)

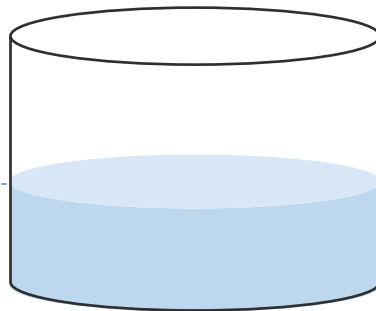

(1)

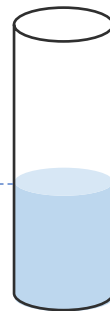

(3)





どちらがおいしい？

● はいっているみずが
おいしいじゅんばん



日にち： 月 日

名まえ _____

- ・ はいっているみずがおいしいじゅんに 1, 2, 3をかきましょう。(うすいじはなぞりましょう。)

①

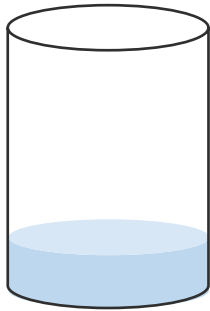

(3)

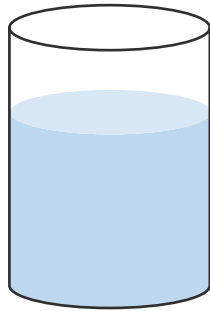

(1)

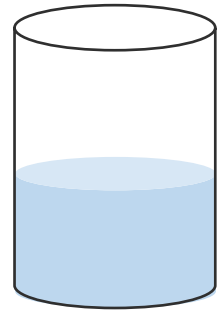

(2)

②

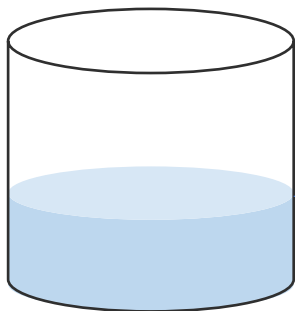

(1)

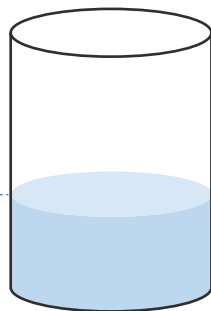

(2)

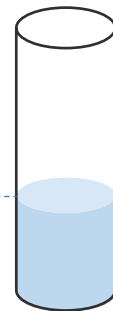

(3)





どちらがおいしい？

● はいっているみずが
おいしいじゅんばん



日にち： 月 日

名まえ _____

- ・ はいっているみずがおいしいじゅんに 1, 2, 3をかきましょう。

①

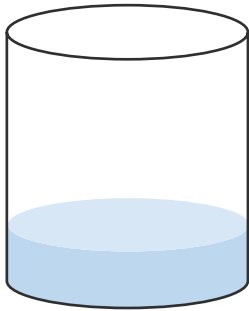

(3)

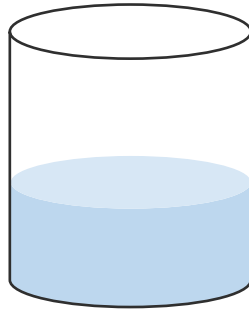

(2)

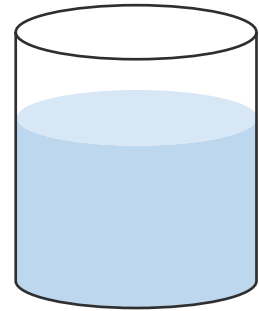

(1)

②

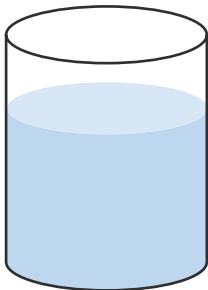

(2)

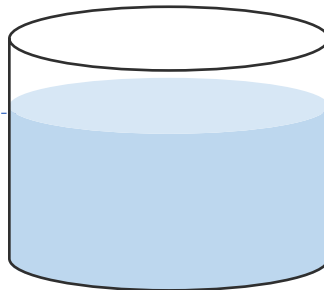

(1)

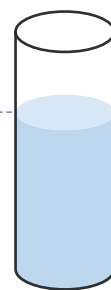

(3)

③ 確認 答え



すらすらぷりんと



どちらがおいしい？

● はいっているみずが
おいしいじゅんばん



日にち： 月 日

名まえ _____

- ・ はいっているみずがおいしいじゅんに 1, 2, 3をかきましょう。

①

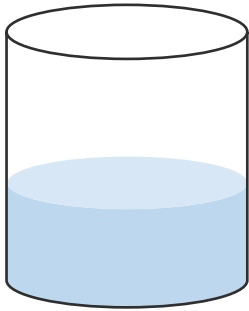

(2)

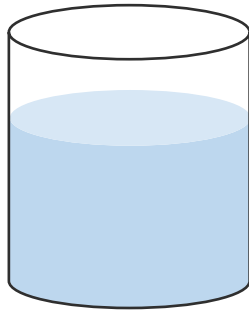

(1)

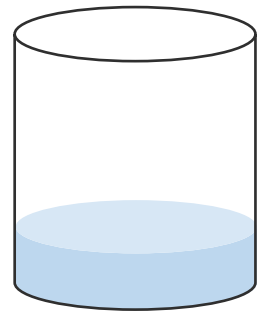

(3)

②

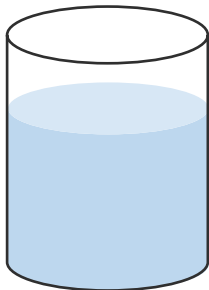

(2)

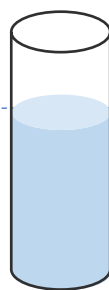

(3)

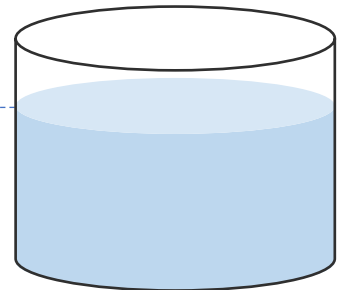

(1)





どちらがおおい2

● はいっているみずが
おおいじゅんばん



日にち： 月 日

名まえ _____

- ・ はいっているみずが おおいじゅんに 1, 2, 3 をかきましょう。

①

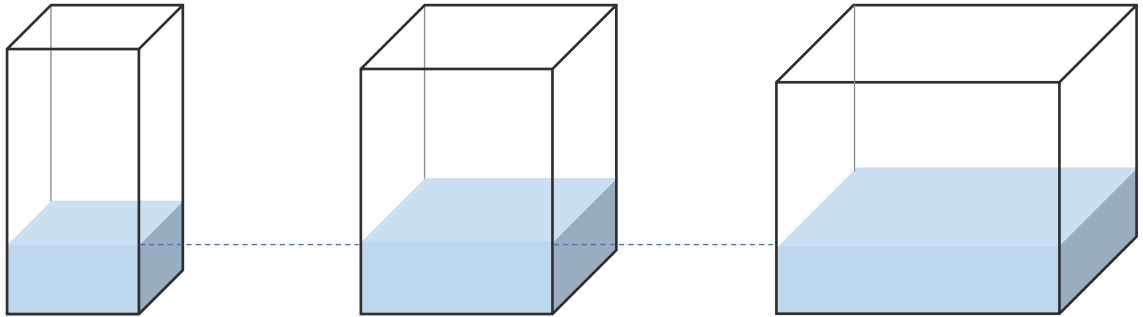

(3)

(2)

(1)

②

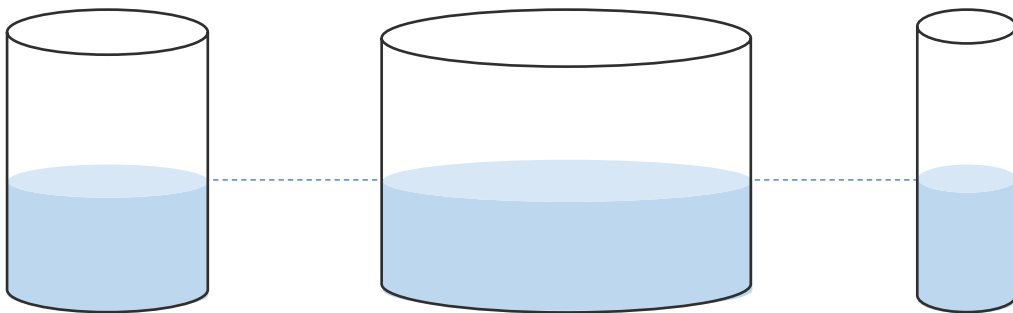

(2)

(1)

(3)





どちらがおおい2

● はいつているみずが
おおいじゅんばん



日にち： 月 日

名まえ _____

- ・ はいつているみずが おおいじゅんばんに 1, 2, 3をかきましょう。

①

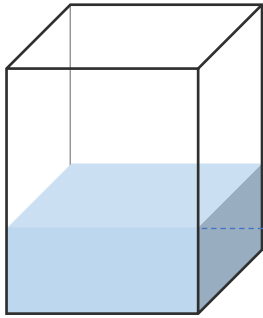

(2)

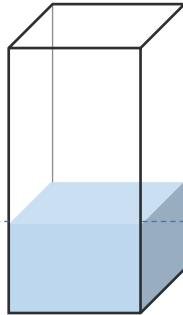

(3)

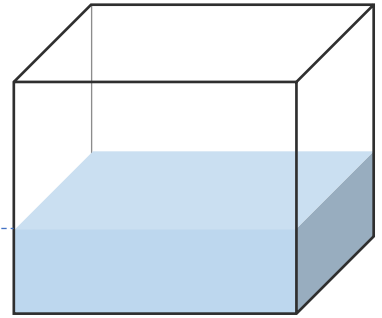

(1)

②

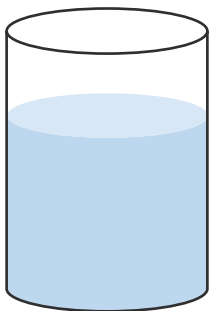

(1)

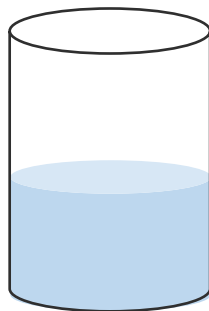

(2)

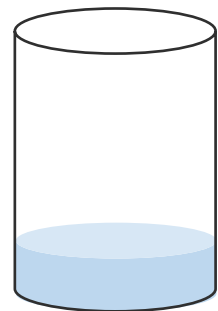

(3)





どちらがおおい 2

● はいっているみずが
おおいじゅんばん



日にち： 月 日

名まえ _____

- ・ はいっているみずが おおいじゅんに 1, 2, 3 をかきましょう。

①

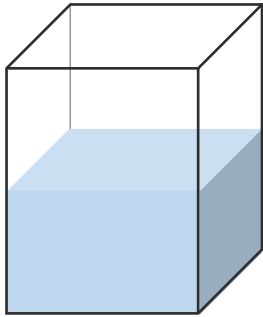

(2)

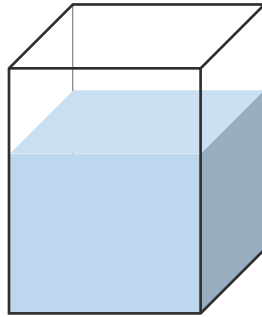

(1)

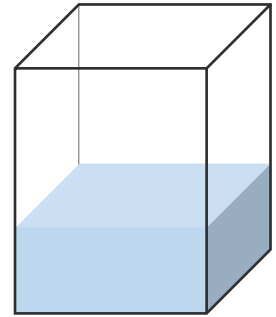

(3)

②

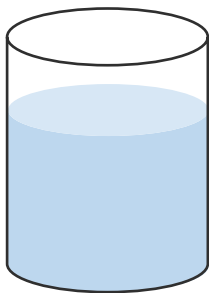

(2)

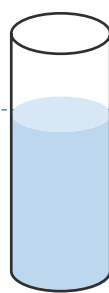

(3)

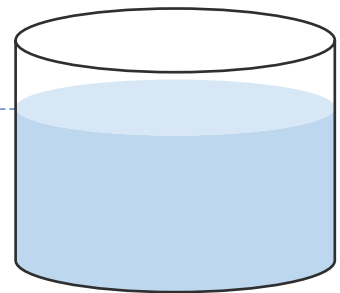

(1)





どちらがおおい 2

● はいつているみずが
おおいじゅんばん



日にち： 月 日

名まえ _____

- ・ はいつているみずが おおいじゅんばんに 1, 2, 3をかきましょう。

①

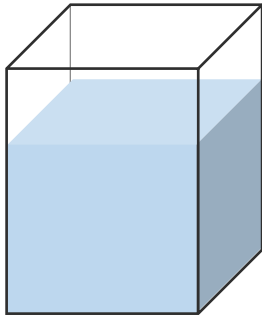

(1)

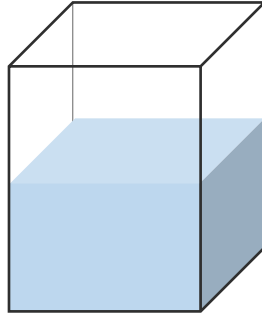

(2)

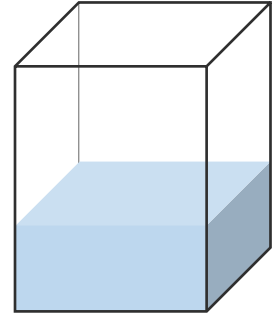

(3)

②

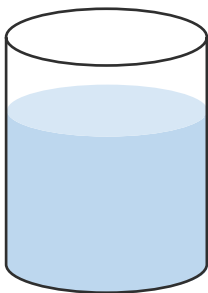

(2)

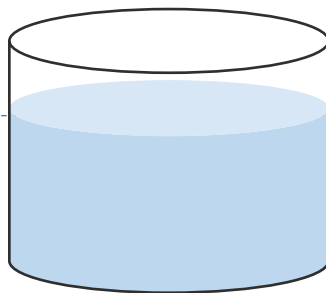

(1)

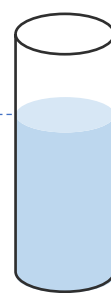

(3)





どちらがおいしい？

● はいつているみずが
おいしいじゅんばん



日にち： 月 日

名まえ _____

- ・ はいつているみずがおいしいじゅんばんに 1, 2, 3をかきましょう。

①

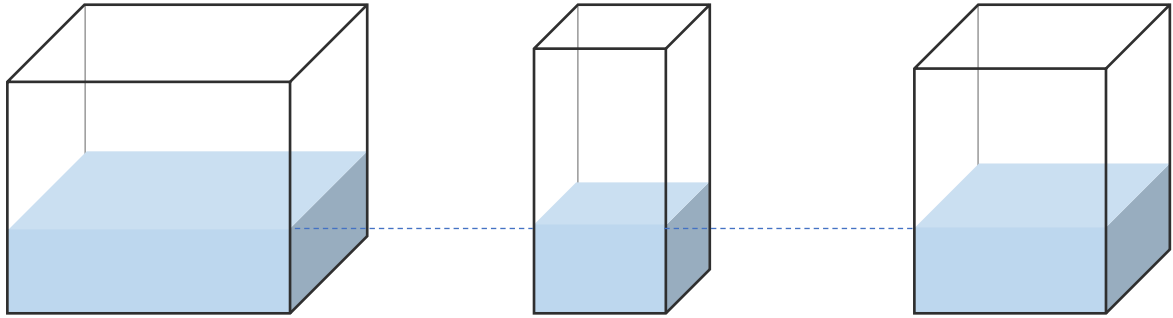

(1)

(3)

(2)

②

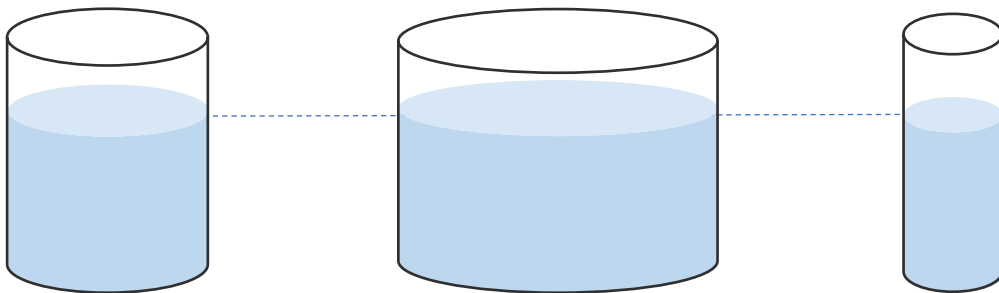

(2)

(1)

(3)

