



4けたの数 13

● いくつずつふえているかな



日にち： 月 日

名まえ _____

・ □ にあう数を書きましょう。(うすい字はなぞりましょう。)

①

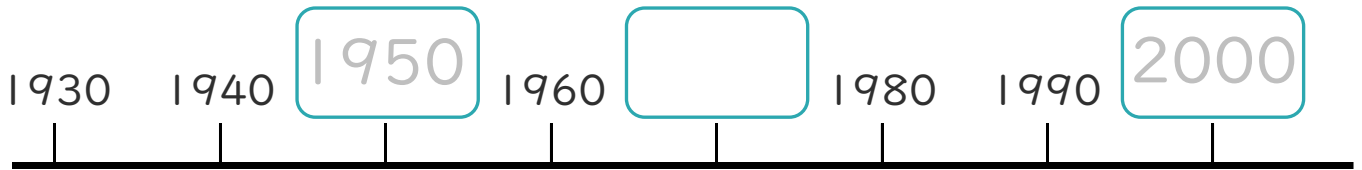

10ずつふえているね!



②

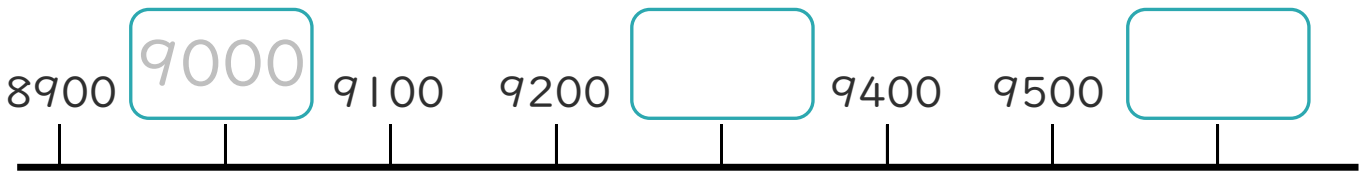

100ずつふえているね!



③

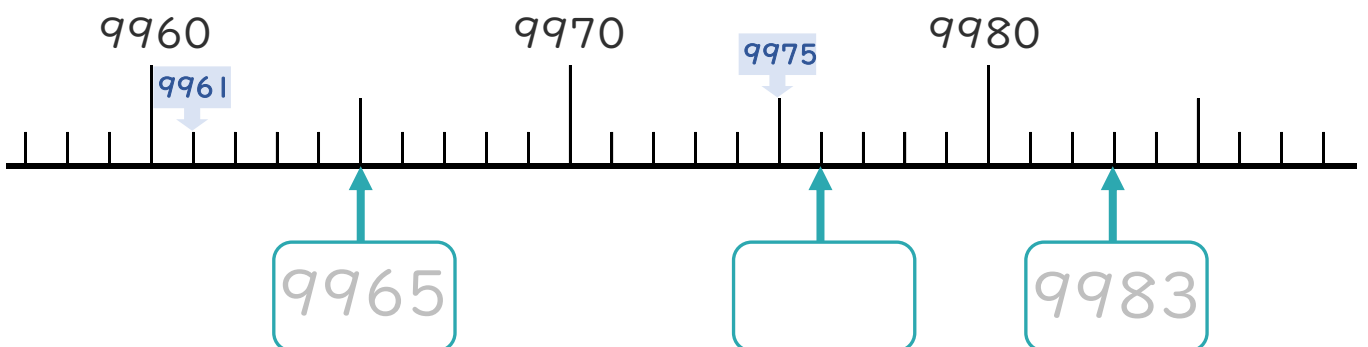

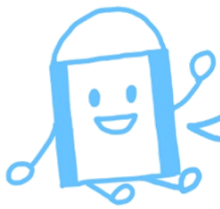

4けたの数 13

● いくつずつふえているかな



日にち： 月 日

名まえ _____

・ □ にあう数を書きましょう。(うすい字はなぞりましょう。)

①



10ずつふえているね!



②



100ずつふえているね!



③



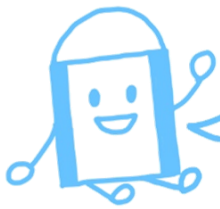

4けたの数 13

● いくつずつふえているかな



日にち： 月 日

名まえ _____

・ □ にあう数を書きましょう。(うすい字はなぞりましょう。)

①



10ずつふえているね!



②

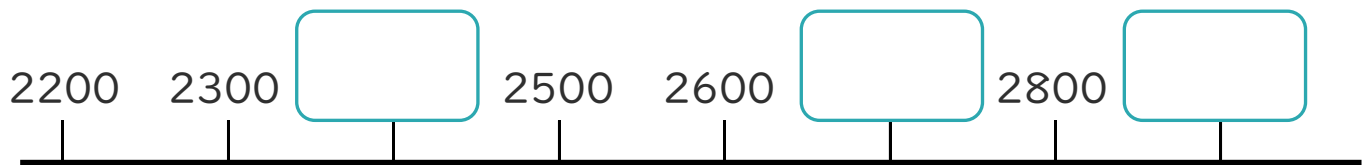

100ずつふえているね!



③

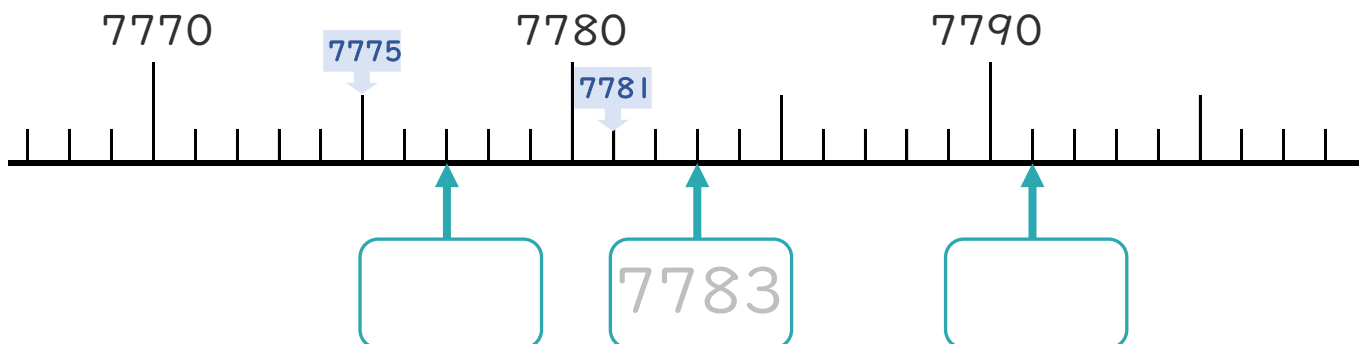

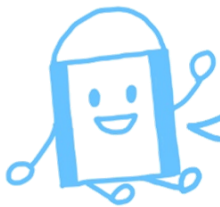

4けたの数 13

◎ いくつずつふえているかな



日にち： 月 日

名まえ _____

・ □ にあう数を書きましょう。

①

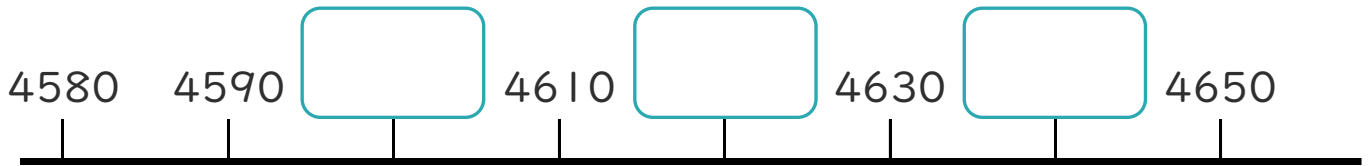

10ずつふえているね!



②



100ずつふえているね!



③

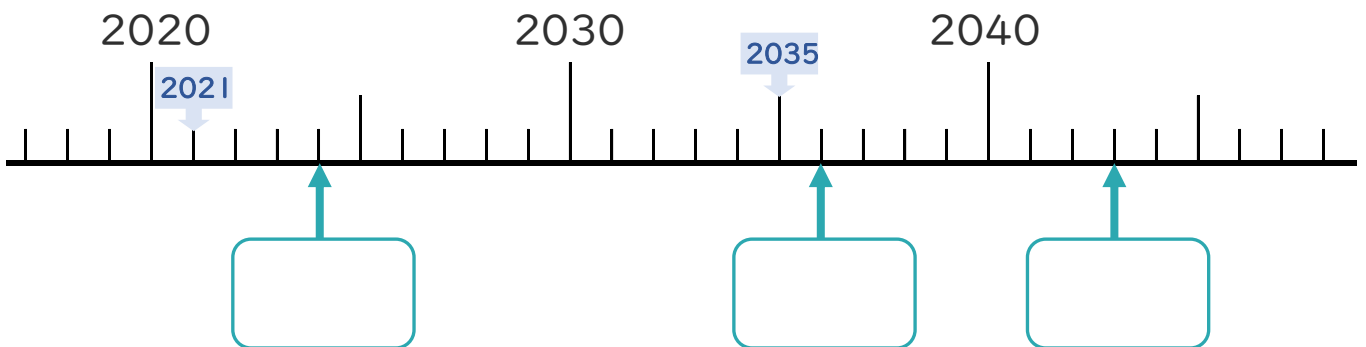



4けたの数 13

◎ いくつずつふえているかな



日にち： 月 日

名まえ _____

・ □ にあう数を書きましょう。(うすい字はなぞりましょう。)

①

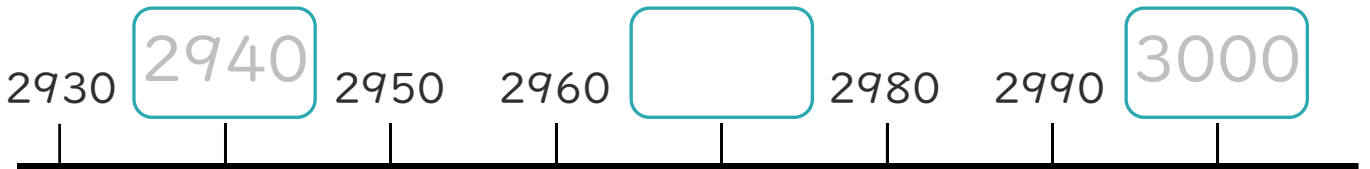

②

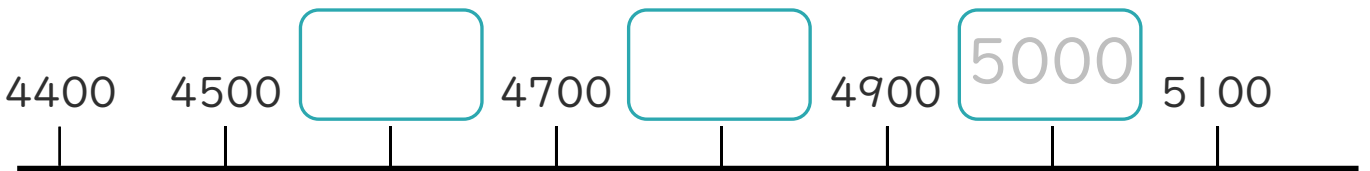

③

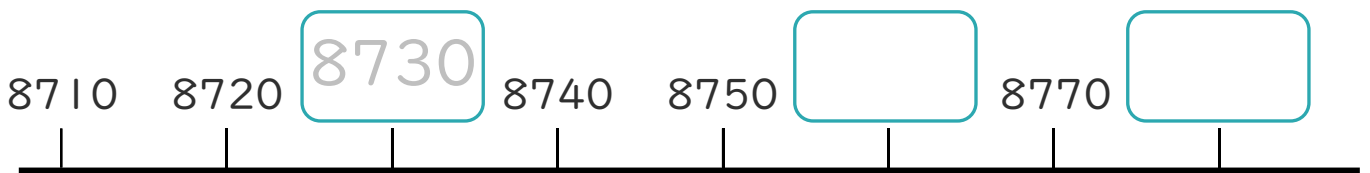

④

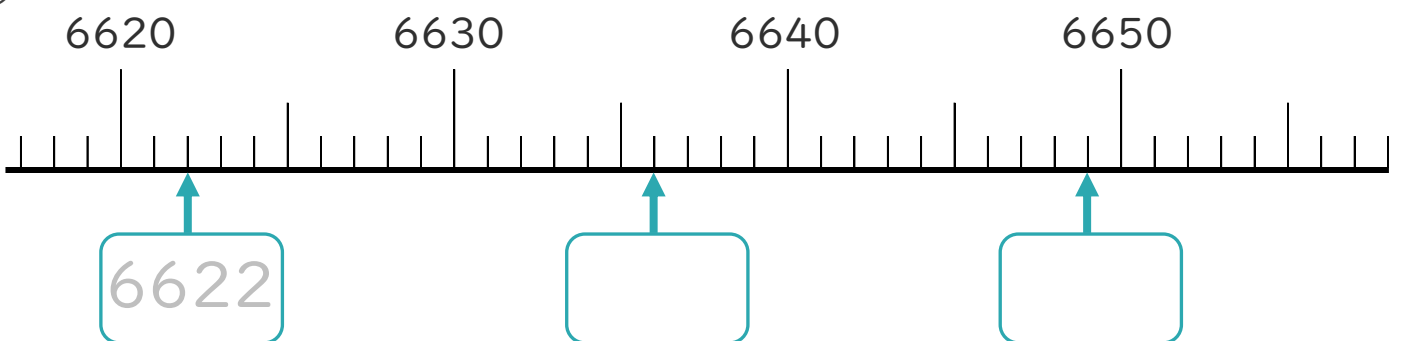



4けたの数 13

◎ いくつずつふえているかな



日にち： 月 日

名まえ _____

・ □ にあう数を書きましょう。(うすい字はなぞりましょう。)

①

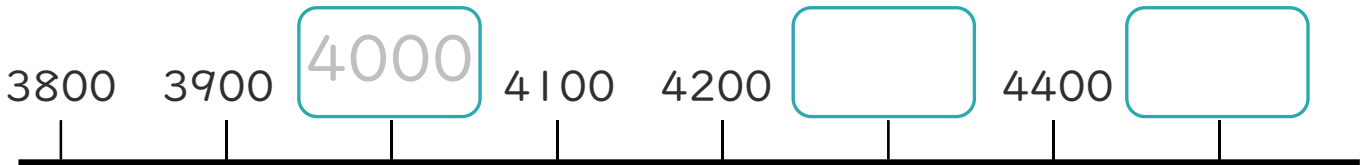

②

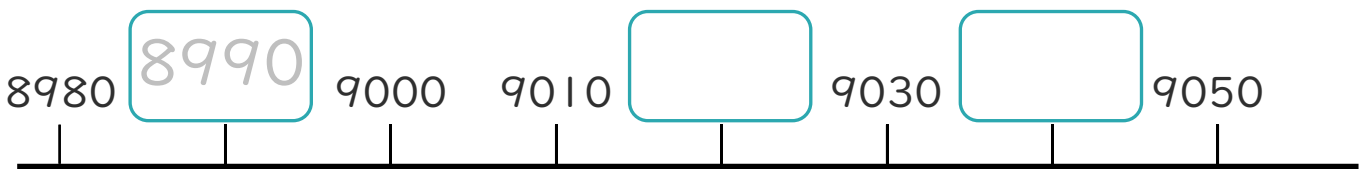

③

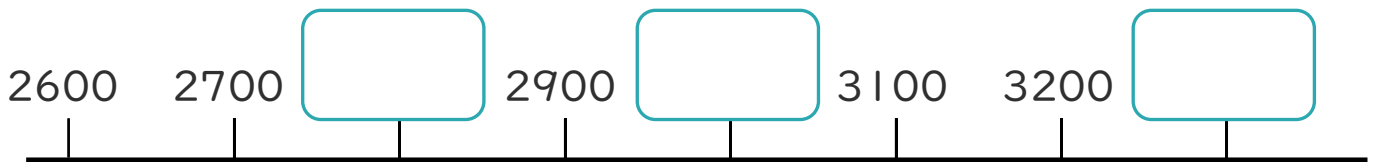

④

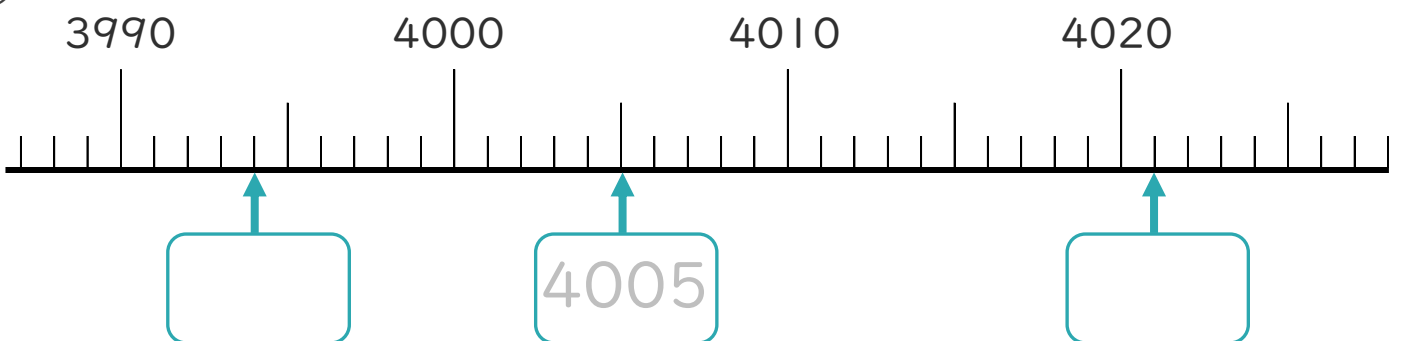



4けたの数 13

◎ いくつずつふえているかな



日にち： 月 日

名まえ _____

・ □ にあう数を書きましょう。(うすい字はなぞりましょう。)

①

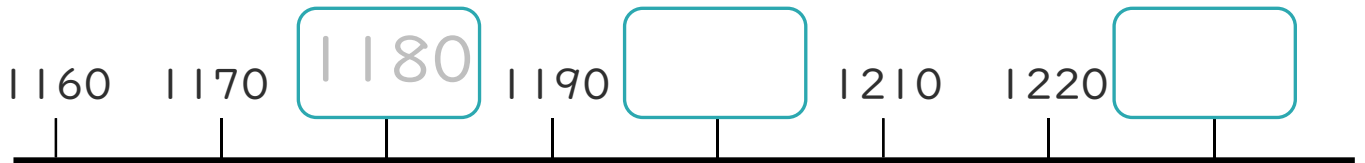

②

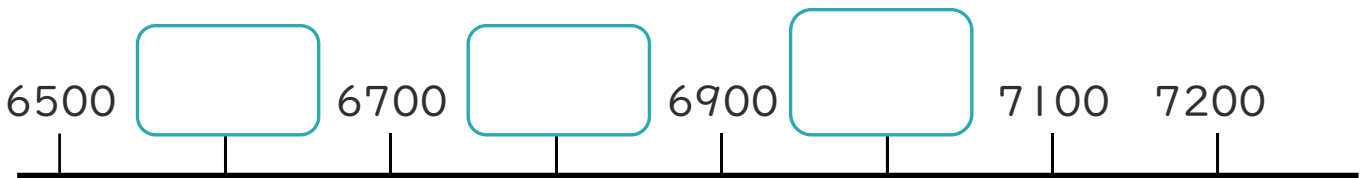

③

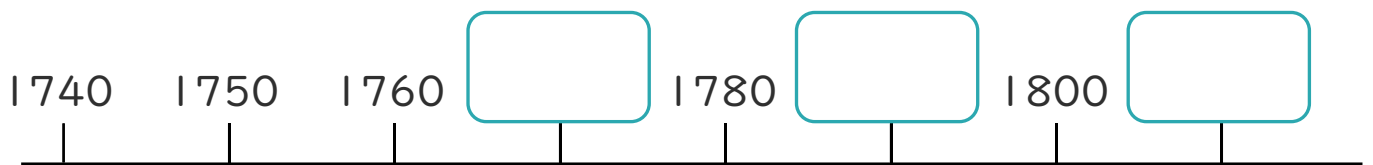

④

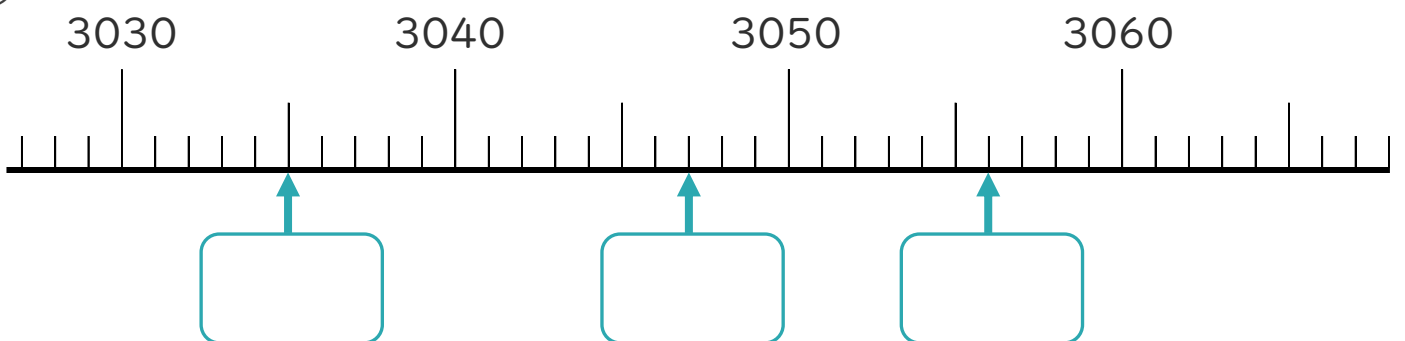

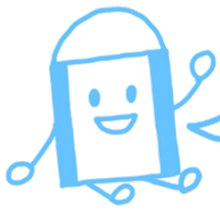

4けたの数 13

◎ いくつずつふえているかな



日にち： 月 日

名まえ _____

・ □ にあう数を書きましょう。

①

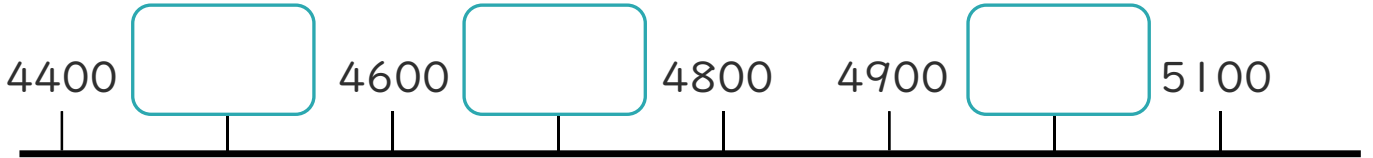

②

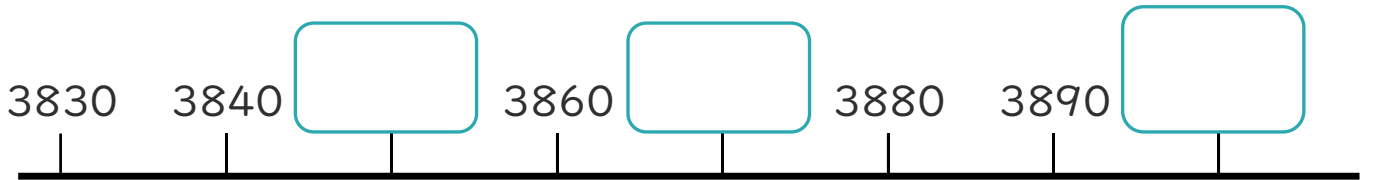

③



④

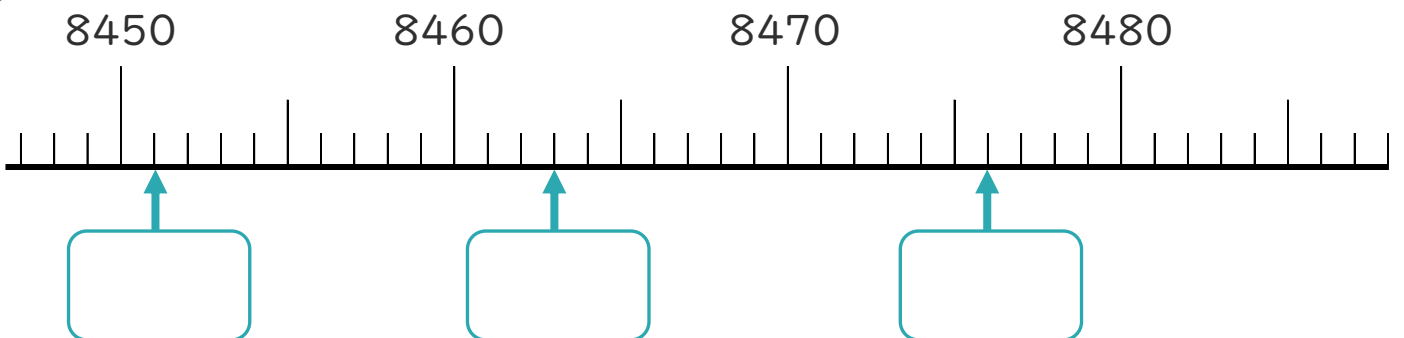



4けたの数 13

◎ いくつずつふえているかな



日にち： 月 日

名まえ _____

・ □ にあう数を書きましょう。

①

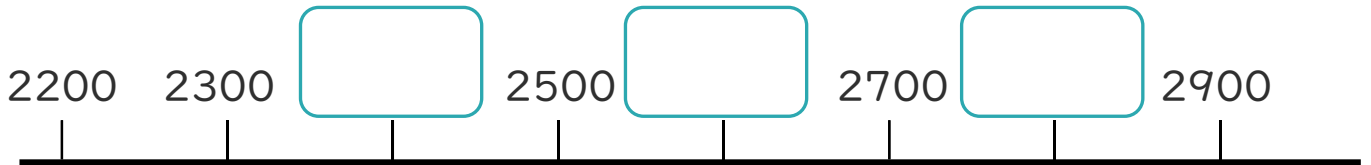

②

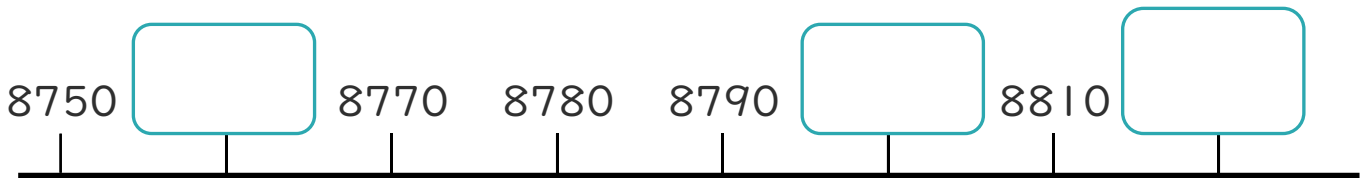

③

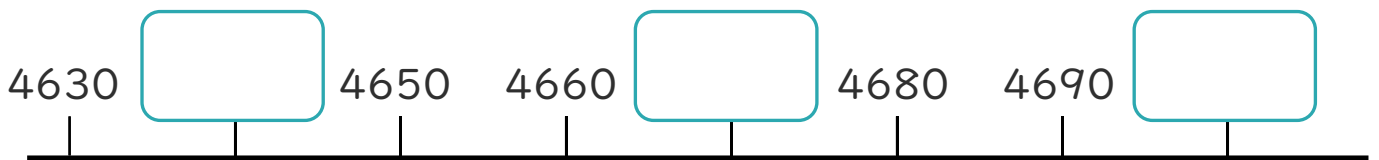

④

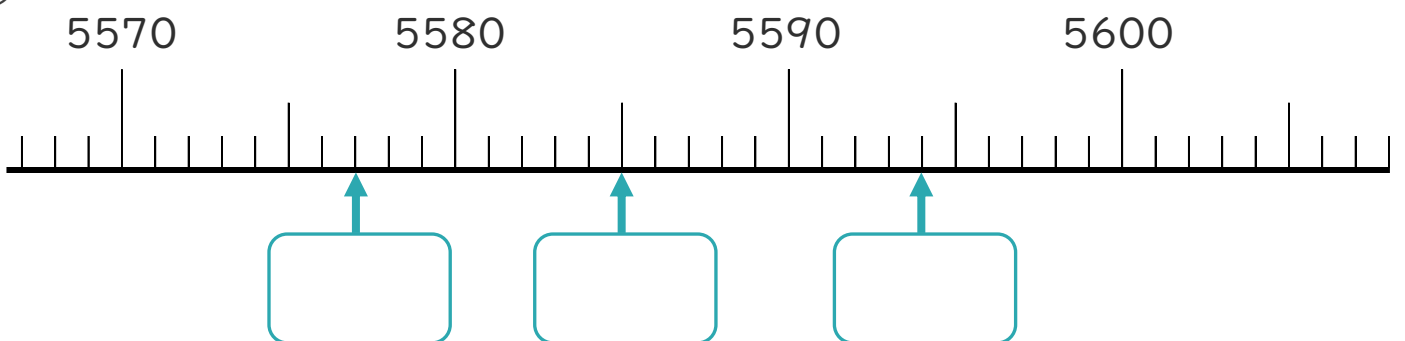

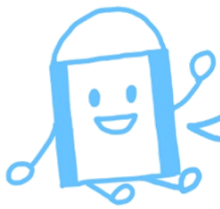

4けたの数 13

◎ いくつずつふえているかな



日にち： 月 日

名まえ _____

1 □ にあう数を書きましょう。

①

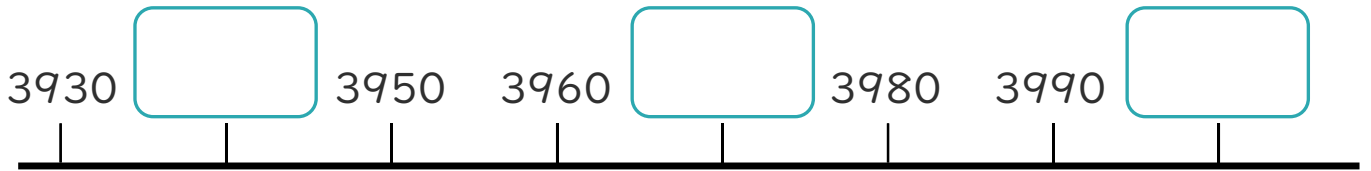

②

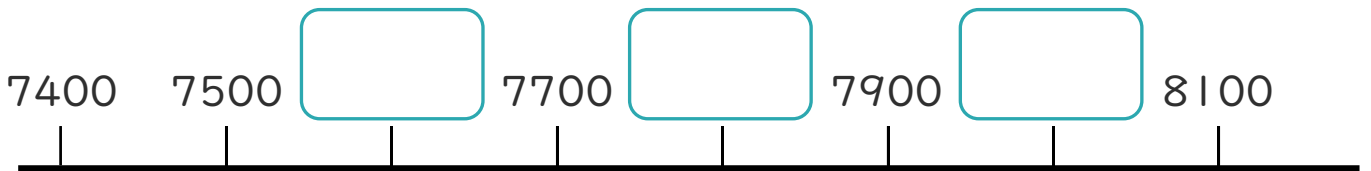

③

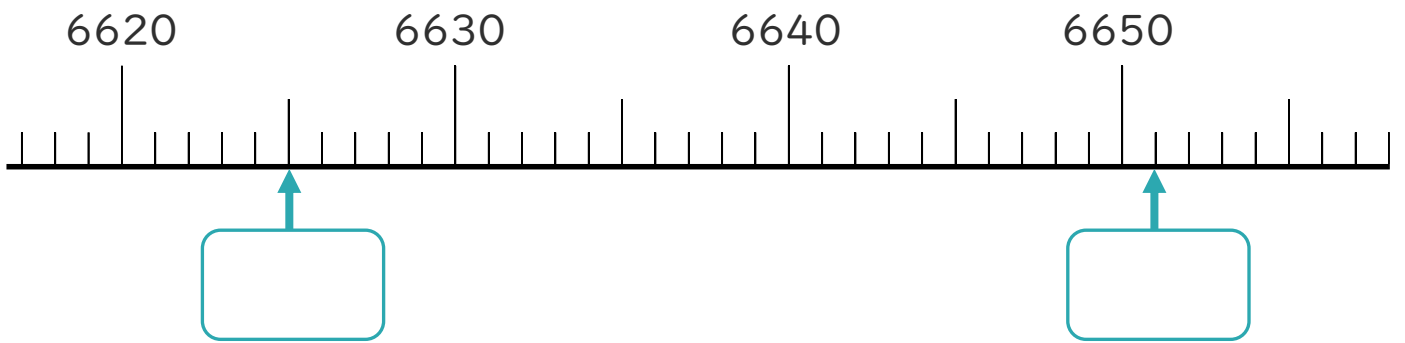

2 次の数を表すめもりに、↑ を書きましょう。

① 300 ② 2900

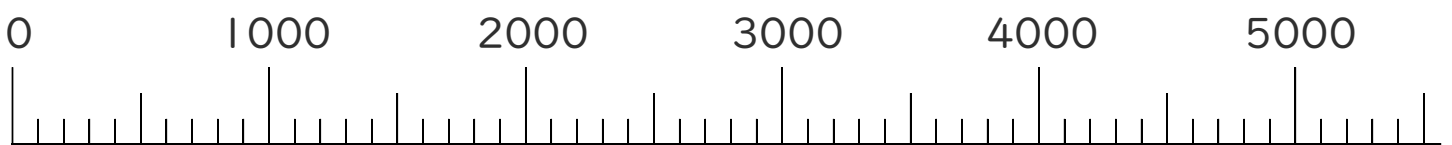

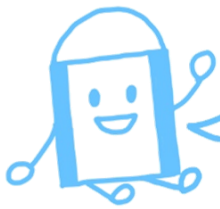

4けたの数 13

◎ いくつずつふえているかな



日にち： 月 日

名まえ _____

1 □ にあう数を書きましょう。

①



②



③

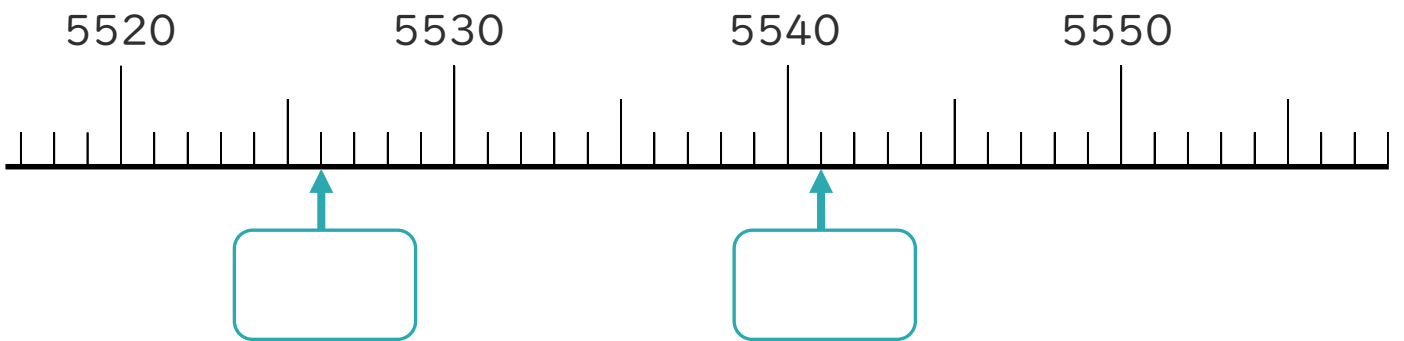

2 次の数を表すめもりに、↑ を書きましょう。

① 4400 ② 8600

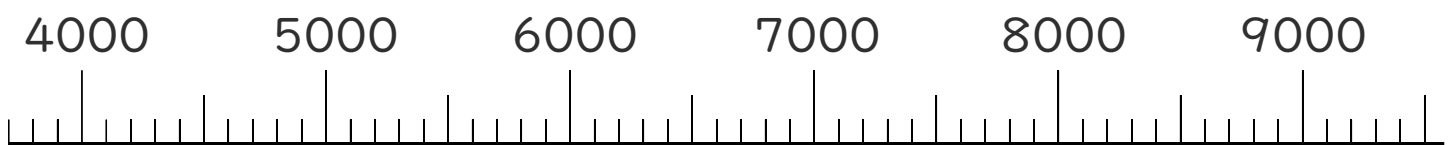

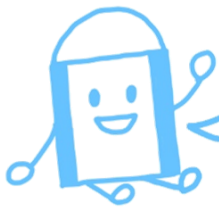

4けたの数 13

◎ いくつずつふえているかな



日にち： 月 日

名まえ _____

1 □ にあう数を書きましょう。

①

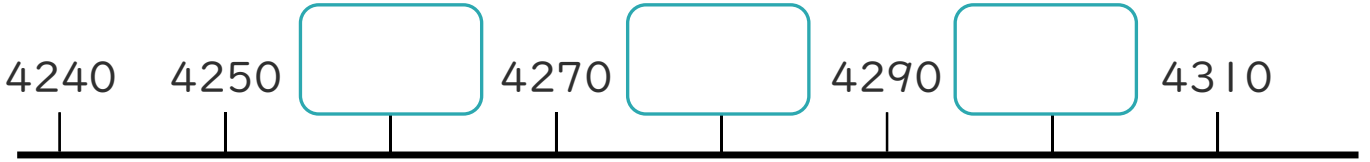

②



③

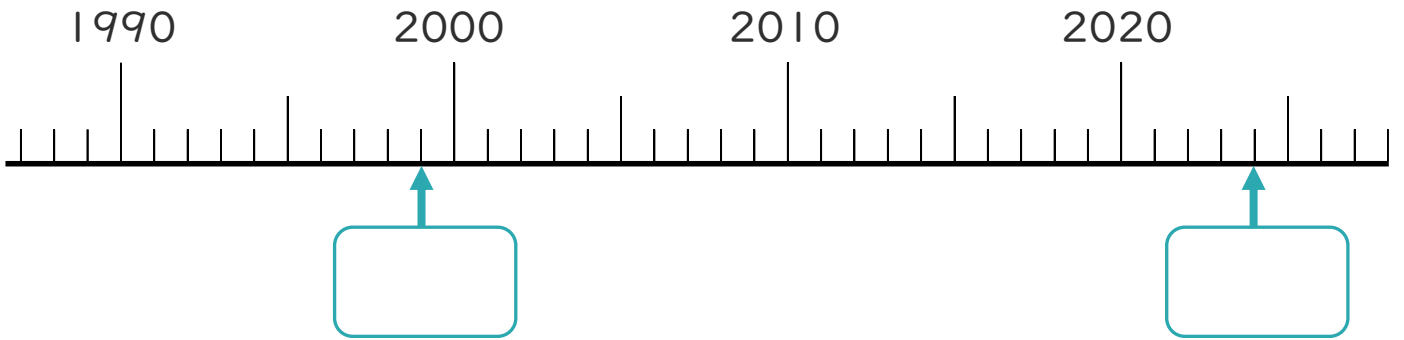

2 次の数を表すめもりに、↑ を書きましょう。

① 600 ② 3100

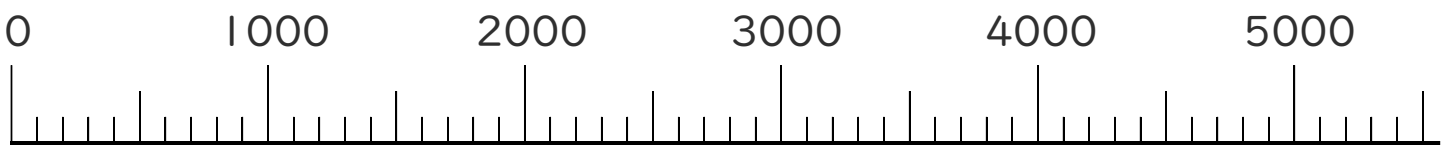



4けたの数 13

◎ いくつずつふえているかな



日にち： 月 日

名まえ _____

1 □ にあう数を書きましょう。

①

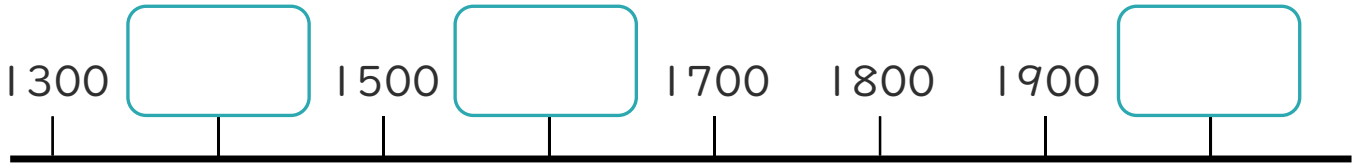

②

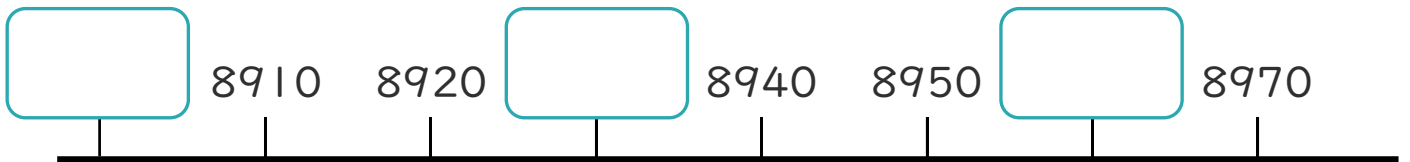

③

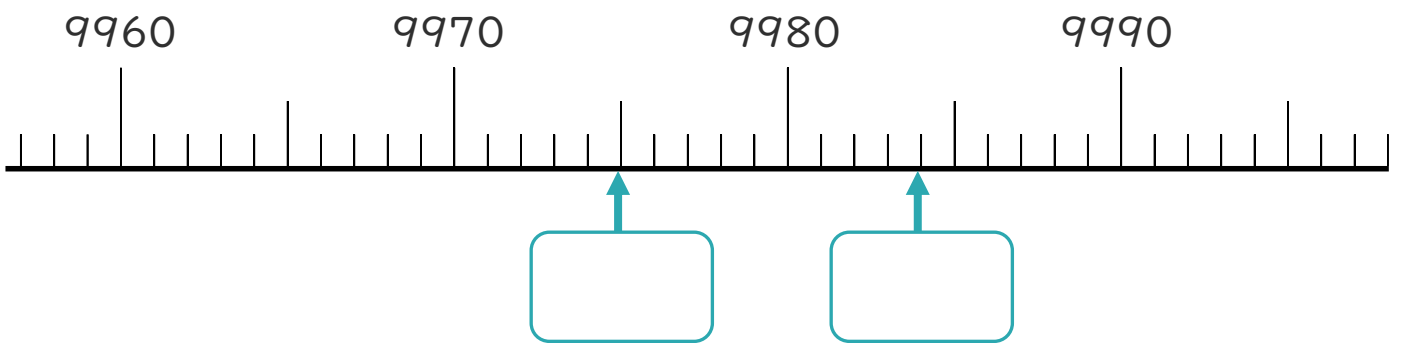

2 次の数を表すメモリに、↑ を書きましょう。

① 5500 ② 7700

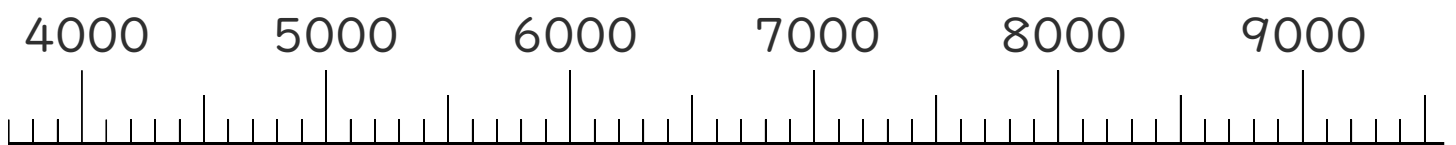



4けたの数 13

◎ いくつずつふえているかな



日にち： 月 日

名まえ _____

1 □ にあう数を書きましょう。

①

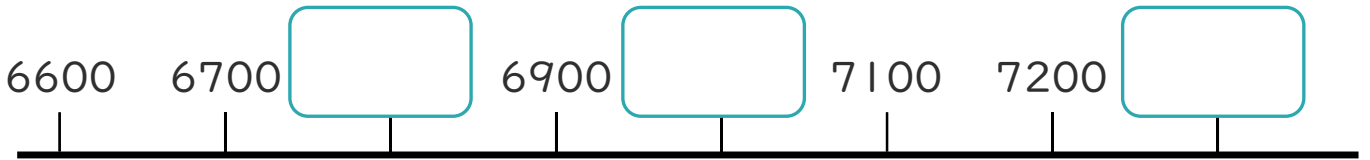

②

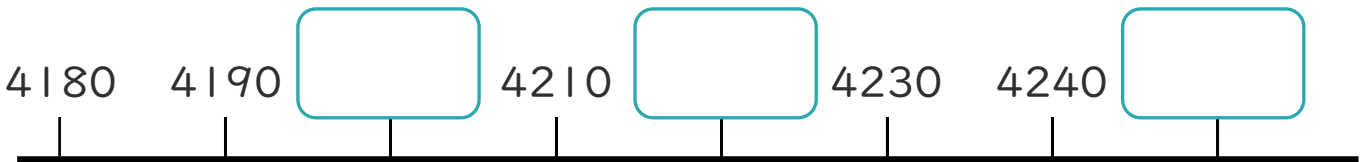

③

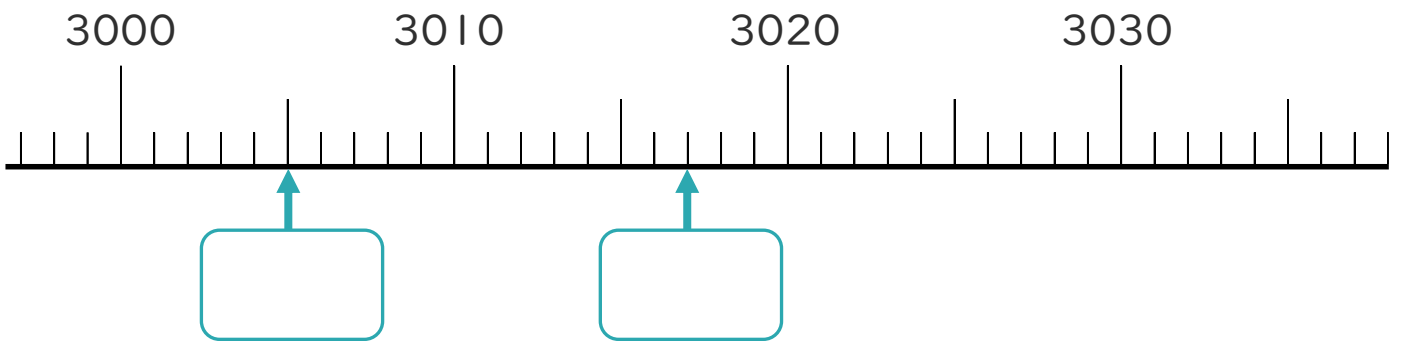

2 次の数を表すめもりに、↑ を書きましょう。

① 900 ② 2600

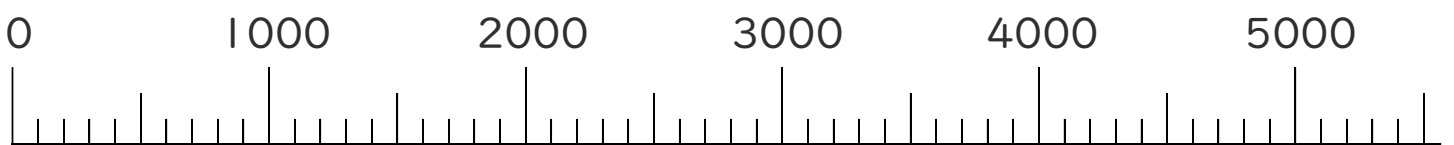



4けたの数 13

◎ いくつずつふえているかな



めざせ90点!



名まえ _____

1 □ にあう数を書きましょう。(各10点)

①

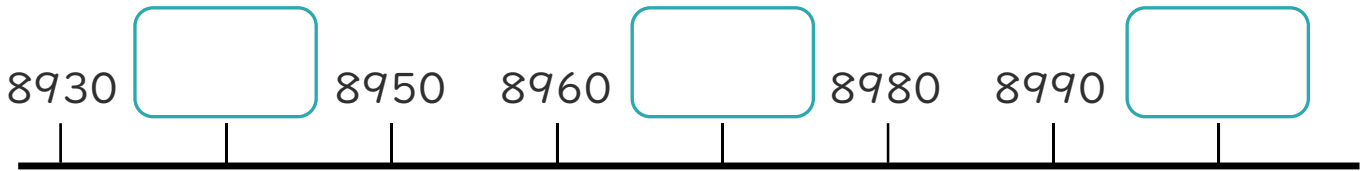

②

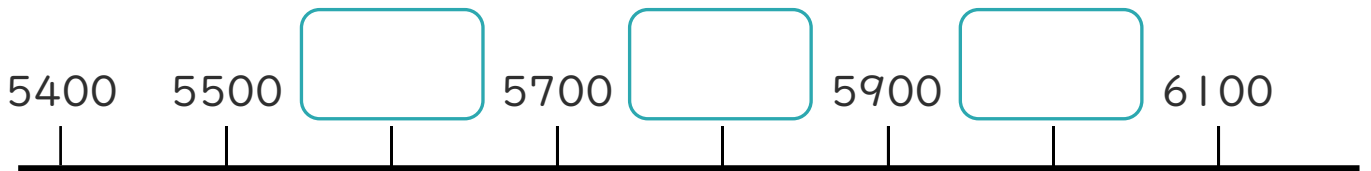

③

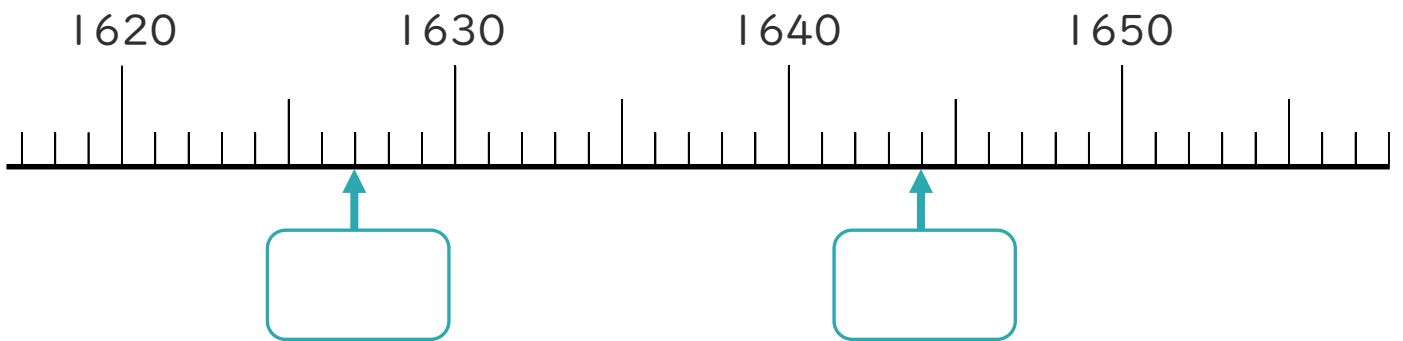

2 次の数を表すめもりに、↑ を書きましょう。(各10点)

① 600 ② 3200

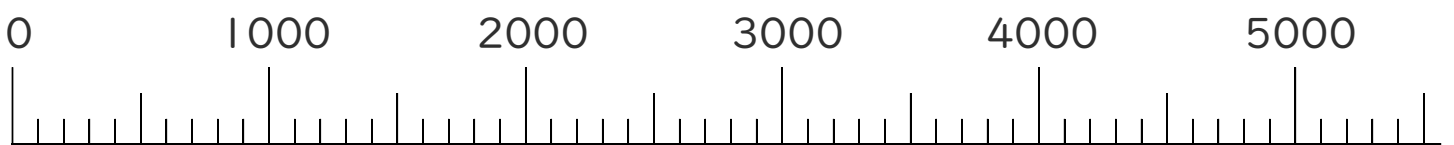

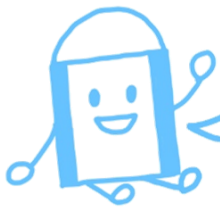

4けたの数 13

◎ いくつずつふえているかな



めざせ90点!



名まえ _____

1 □ にあう数を書きましょう。(各10点)

①

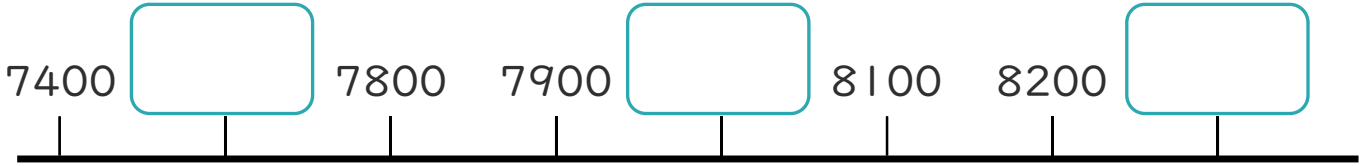

②

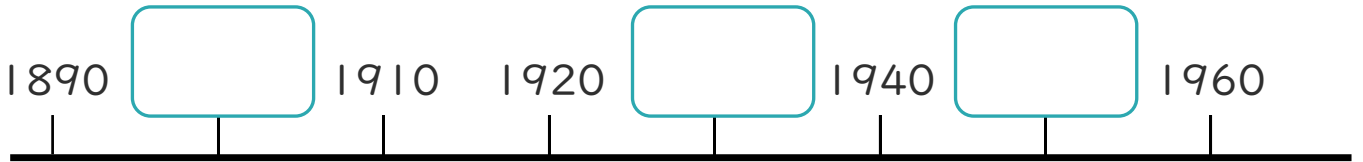

③

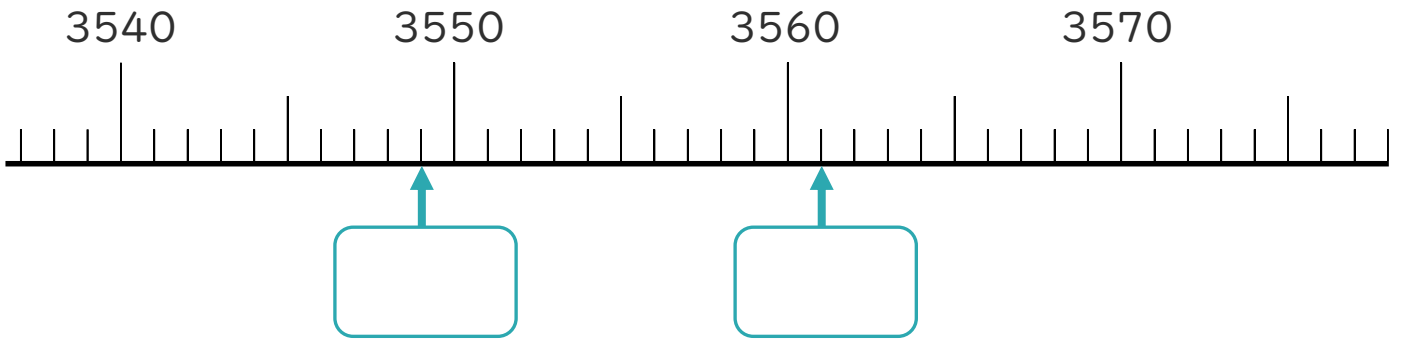

2 次の数を表すめもりに、↑ を書きましょう。(各10点)

① 5900 ② 8200

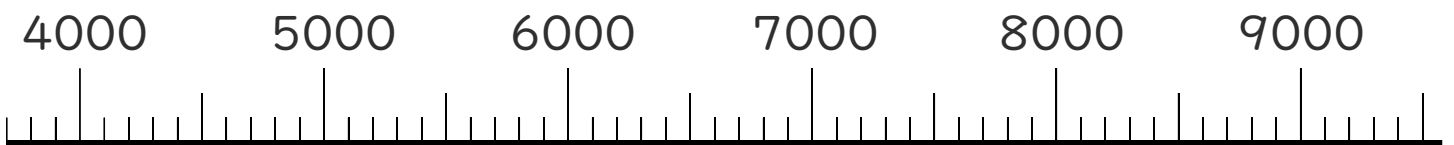



4けたの数 13

◎ いくつずつふえているかな



日にち： 月 日

名まえ _____

・ □ にあう数を書きましょう。(うすい字はなぞりましょう。)

①

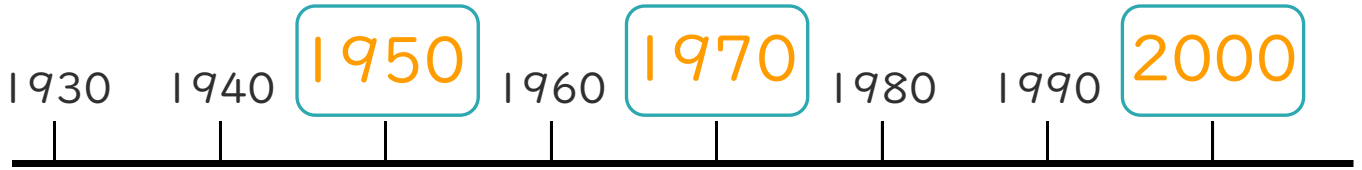

10ずつふえているね!



②

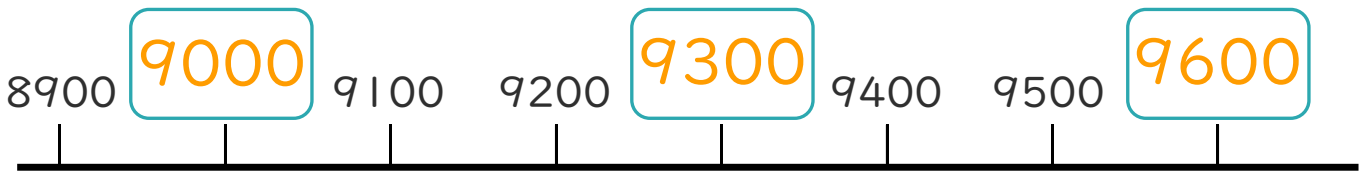

100ずつふえているね!



③

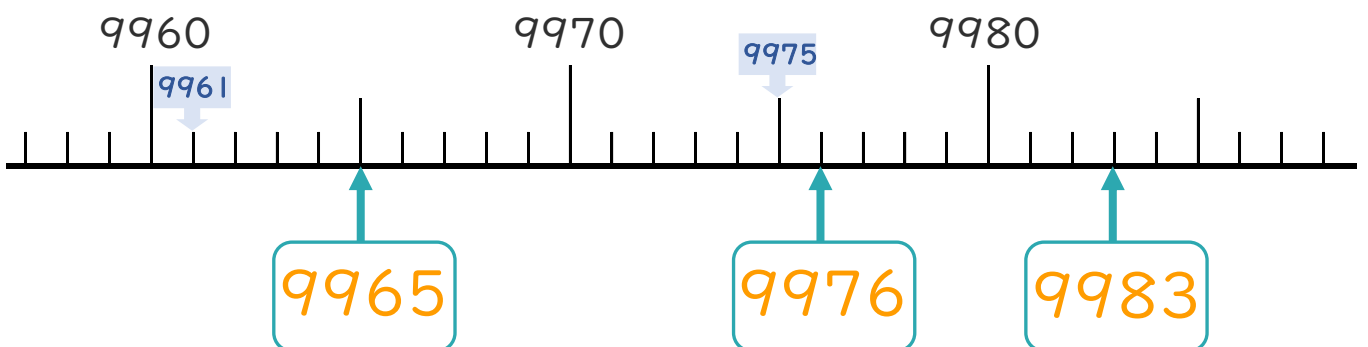

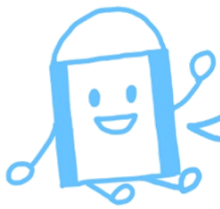

4けたの数 13

◎ いくつずつふえているかな



日にち： 月 日

名まえ _____

・ □ にあう数を書きましょう。(うすい字はなぞりましょう。)

①



②

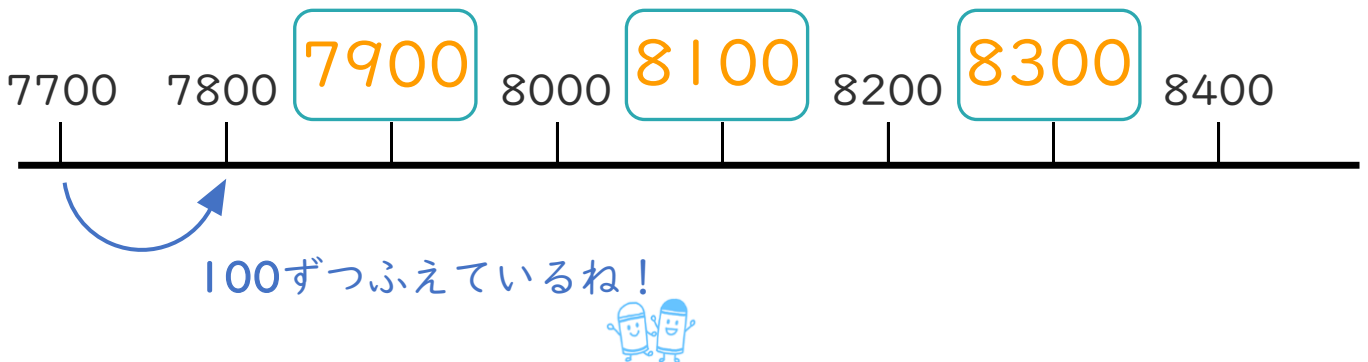

③

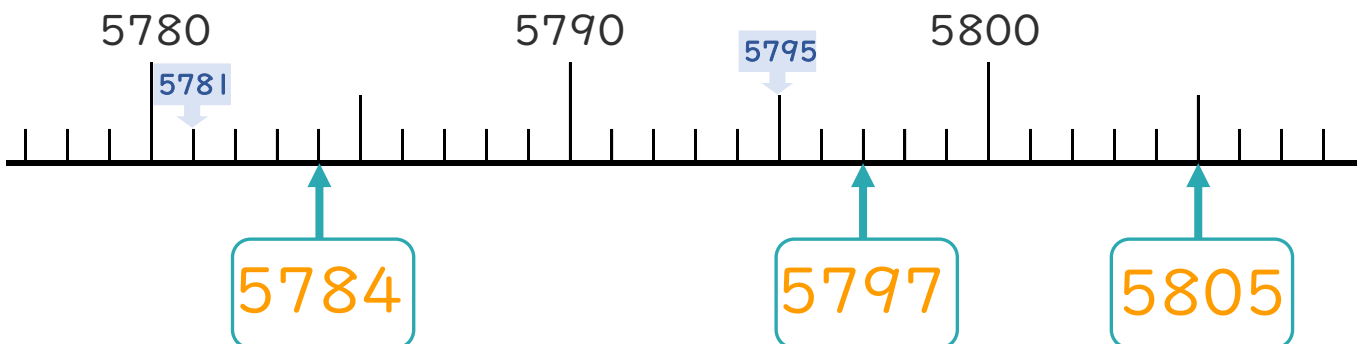

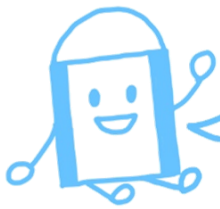

4けたの数 13

● いくつずつふえているかな



日にち： 月 日

名まえ _____

・ □ にあう数を書きましょう。(うすい字はなぞりましょう。)

①



10ずつふえているね!



②

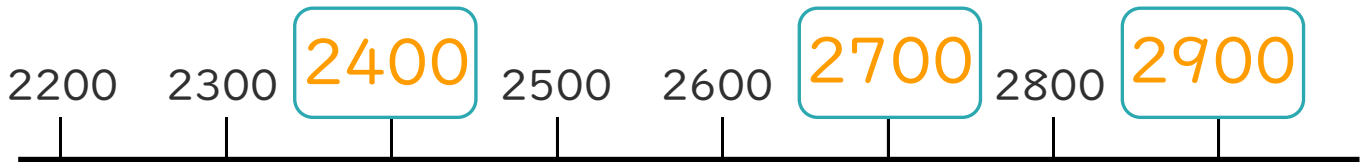

100ずつふえているね!



③

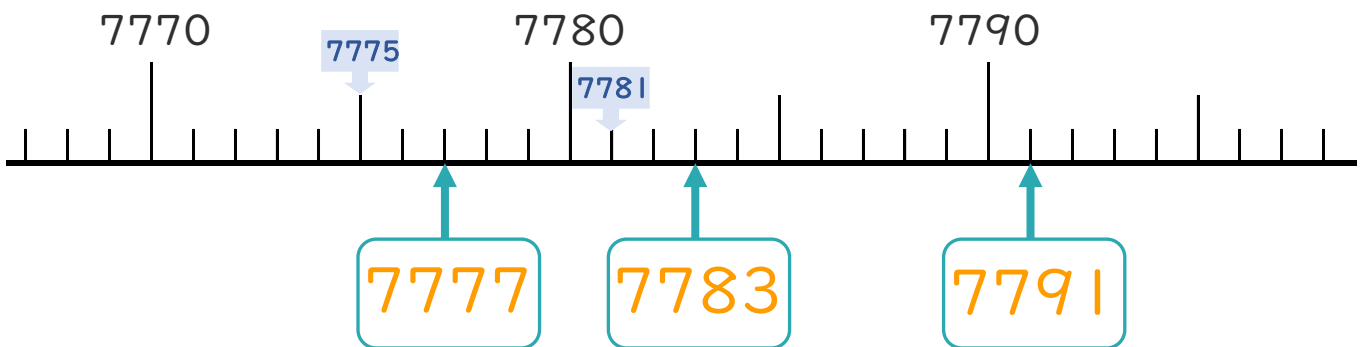

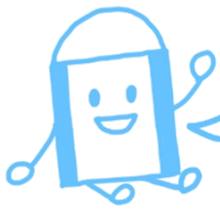

4けたの数 13

◎ いくつずつふえているかな



日にち： 月 日

名まえ _____

・ □ にあう数を書きましょう。

①



10ずつふえているね!



②

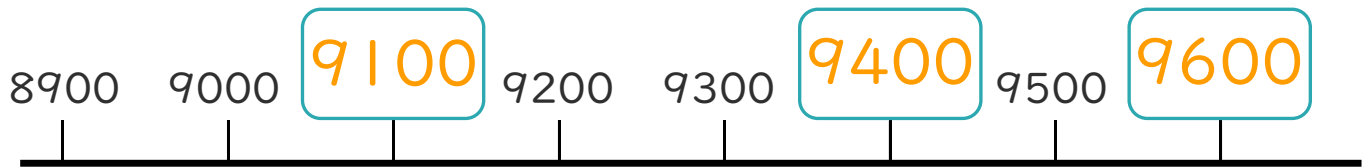

100ずつふえているね!



③

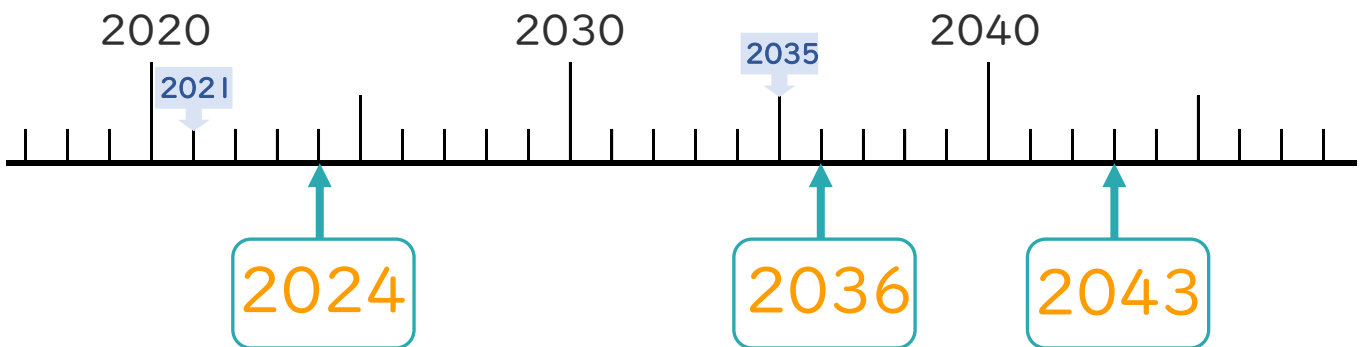

④ 確認 答え





4けたの数 13

◎ いくつつづつふえているかな



日にち： 月 日

名まえ _____

・ □ にあう数を書きましょう。(うすい字はなぞりましょう。)

①

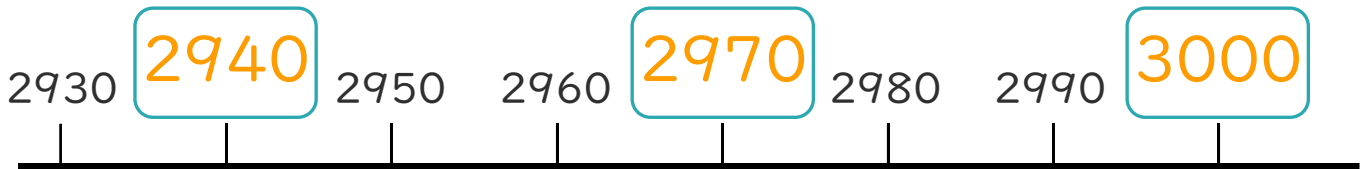

②



③

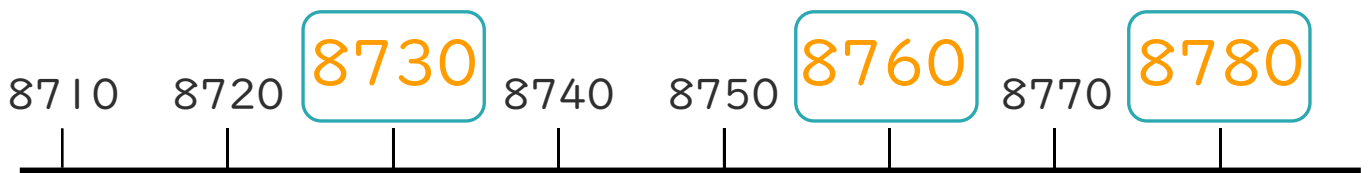

④

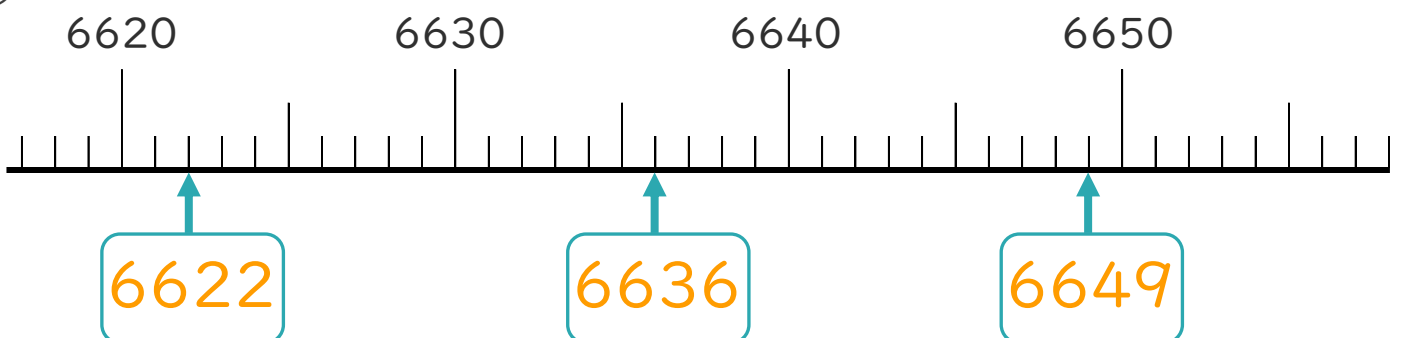



4けたの数 13

◎ いくつずつふえているかな



日にち： 月 日

名まえ _____

・ □ にあう数を書きましょう。(うすい字はなぞりましょう。)

①

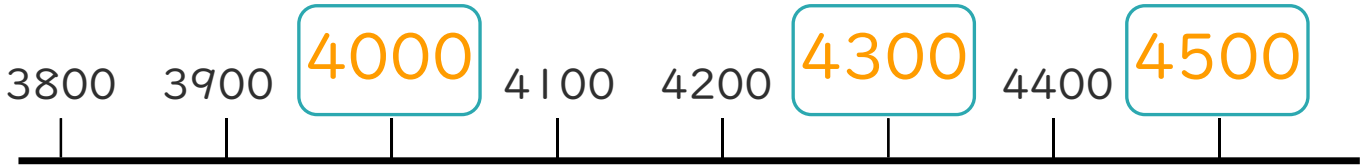

②

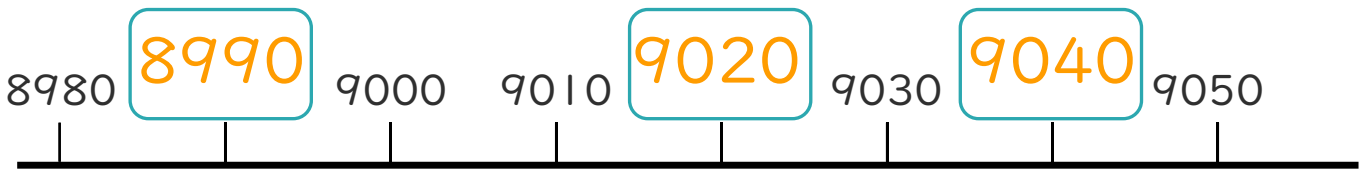

③

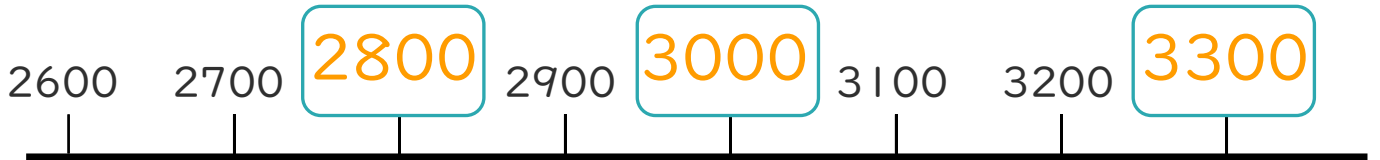

④

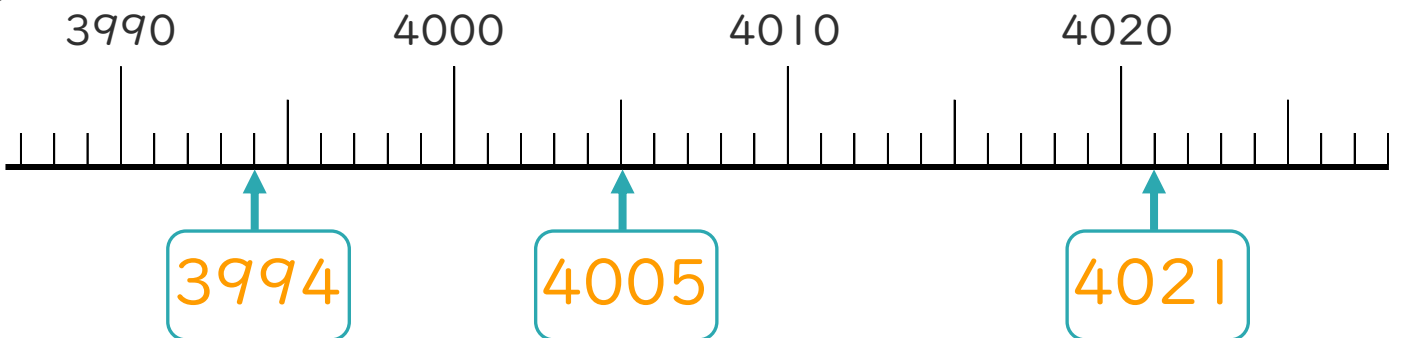



4けたの数 13

● いくつずつふえているかな



日にち： 月 日

名まえ _____

・ □ にあう数を書きましょう。(うすい字はなぞりましょう。)

①



②

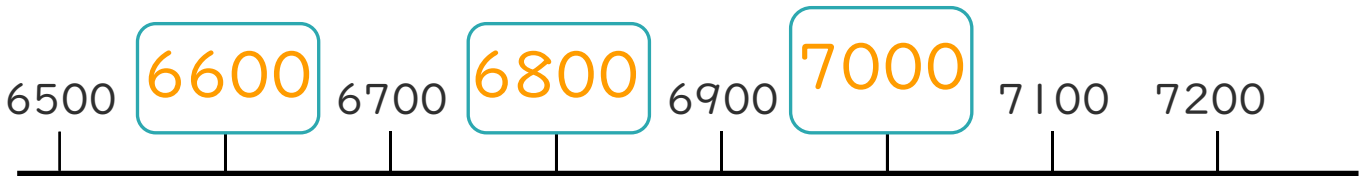

③

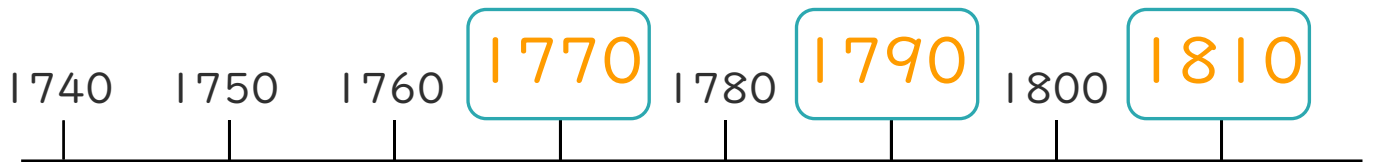

④

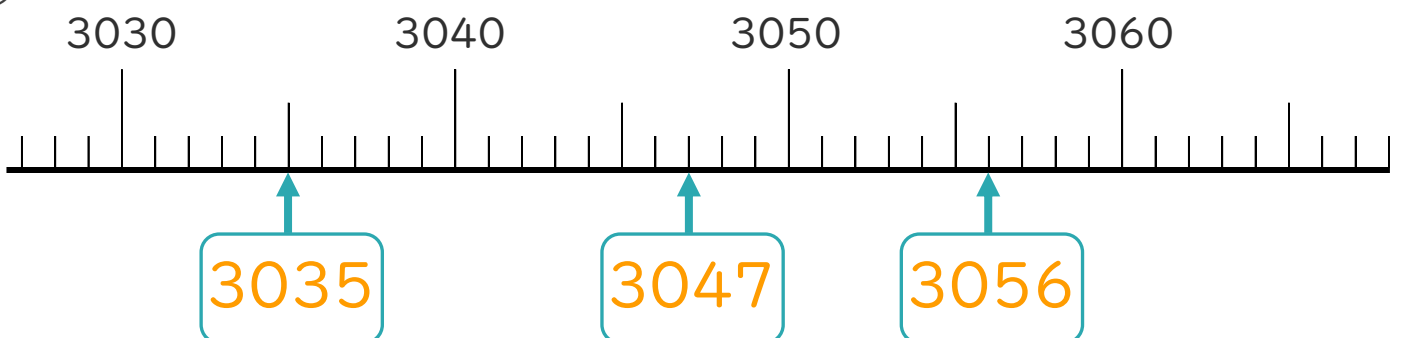

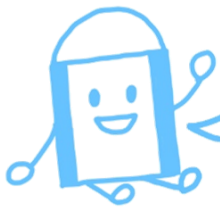

4けたの数 13

◎ いくつずつふえているかな



日にち： 月 日

名まえ _____

・ □ にあう数を書きましょう。

①

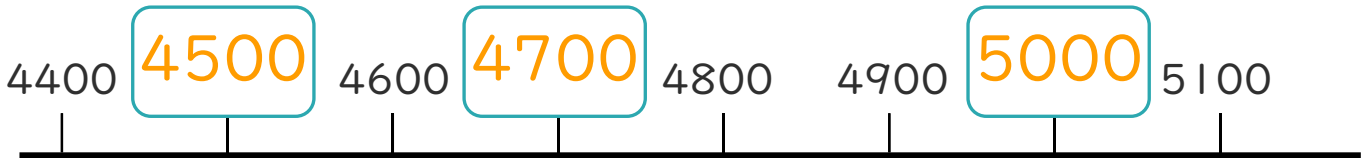

②

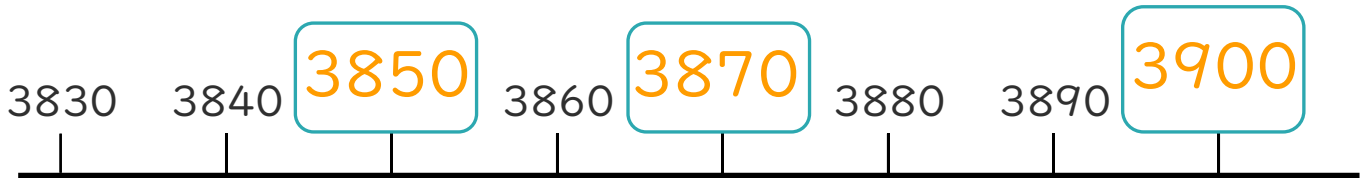

③



④

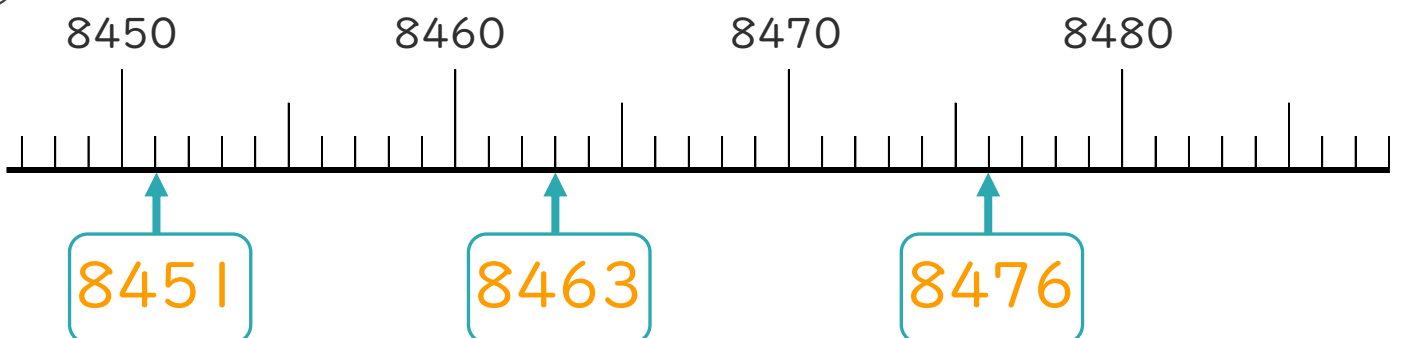



4けたの数 13

◎ いくつずつふえているかな



日にち： 月 日

名まえ _____

・ □ にあう数を書きましょう。

①



②

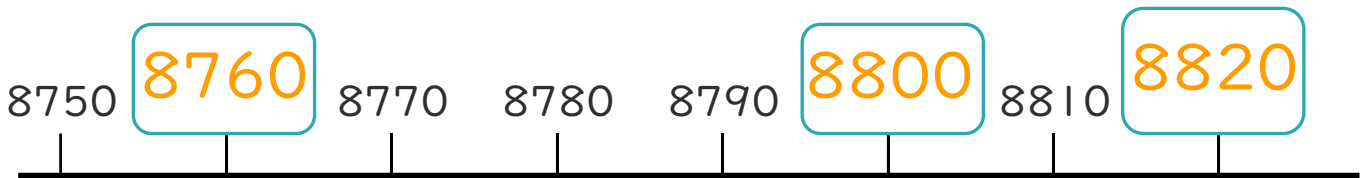

③

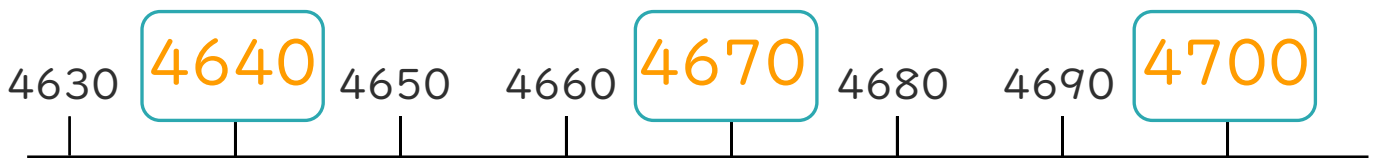

④

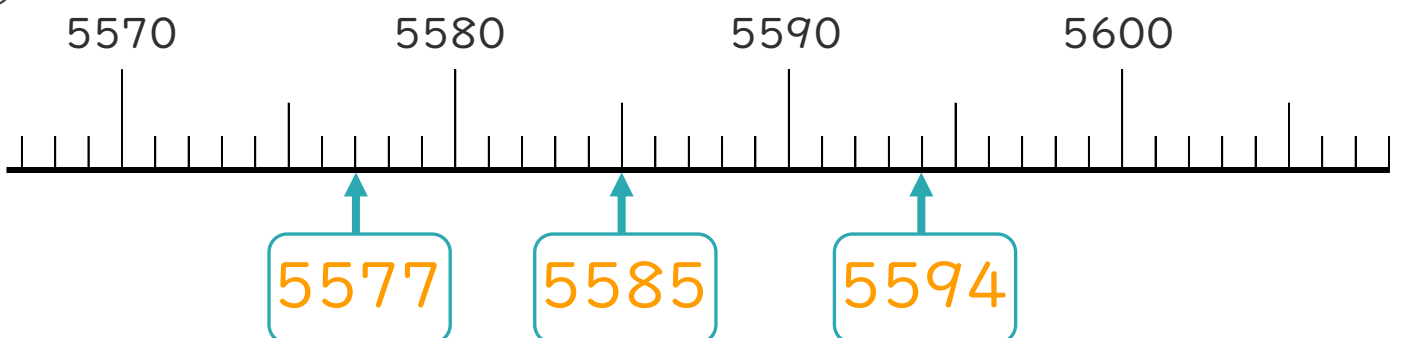

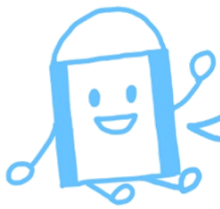

4けたの数 13

◎ いくつずつふえているかな



日にち： 月 日

名まえ _____

1 □ にあう数を書きましょう。

①

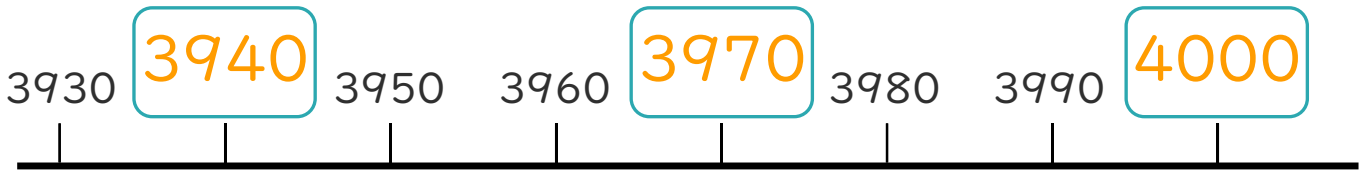

②



③

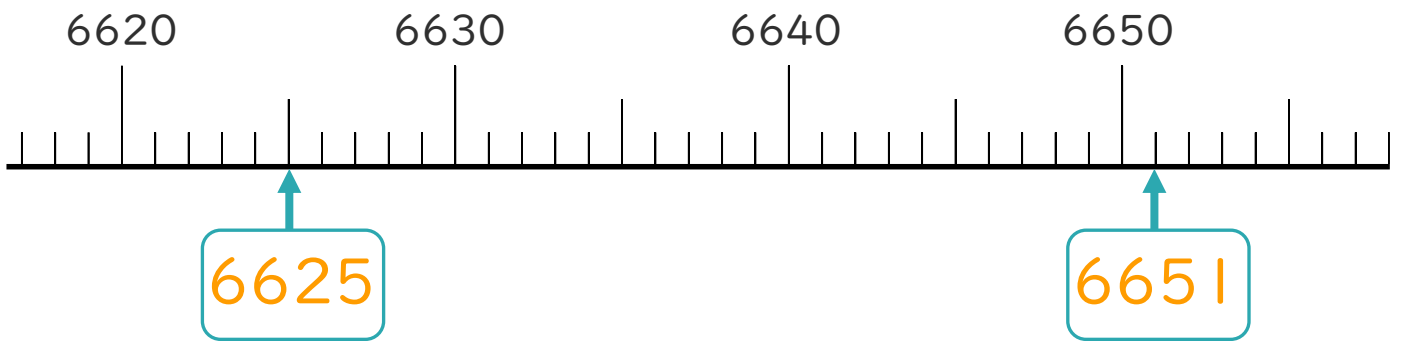

2 次の数を表すめもりに、↑ を書きましょう。

① 300 ② 2900

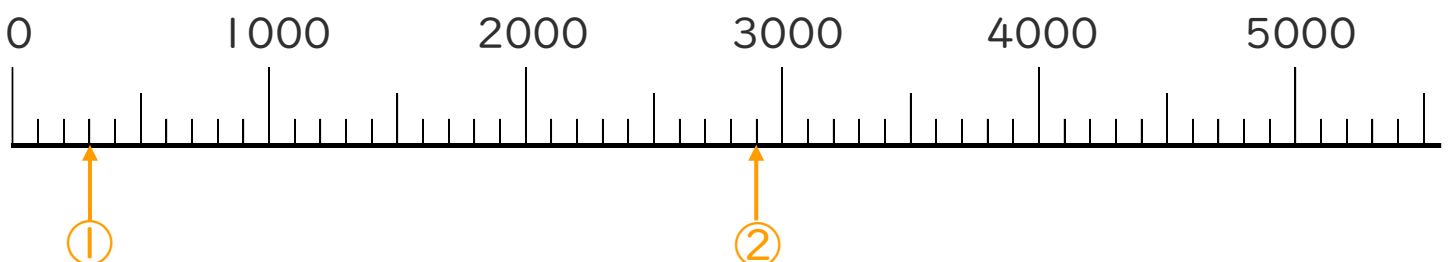

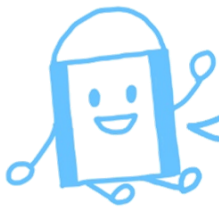

4けたの数 13

◎ いくつずつふえているかな



日にち： 月 日

名まえ _____

1 □ にあう数を書きましょう。

①



②



③

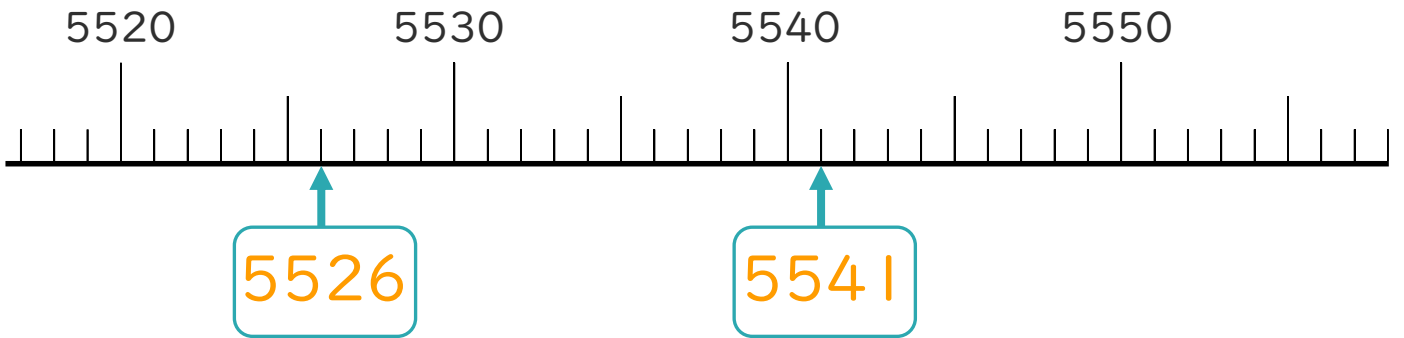

2 次の数を表すめもりに、↑ を書きましょう。

① 4400 ② 8600

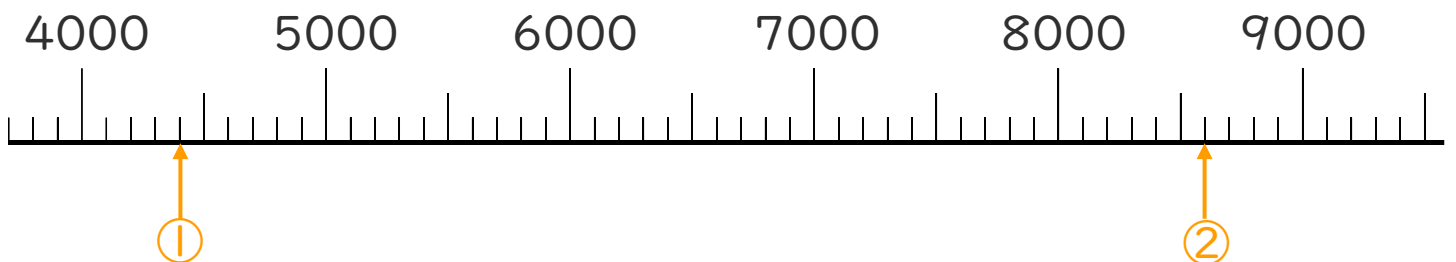

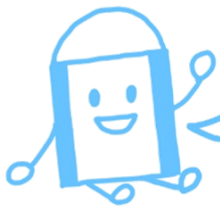

4けたの数 13

◎ いくつずつふえているかな



日にち： 月 日

名まえ _____

1 □ にあう数を書きましょう。

①

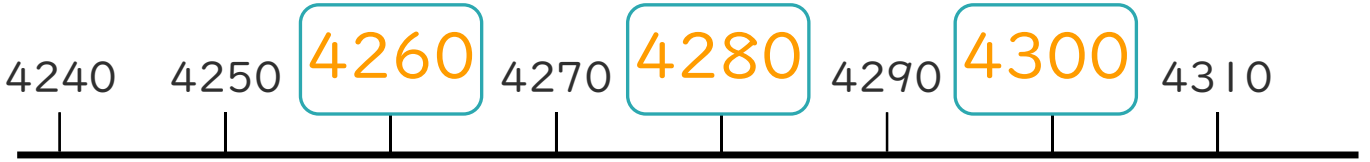

②



③

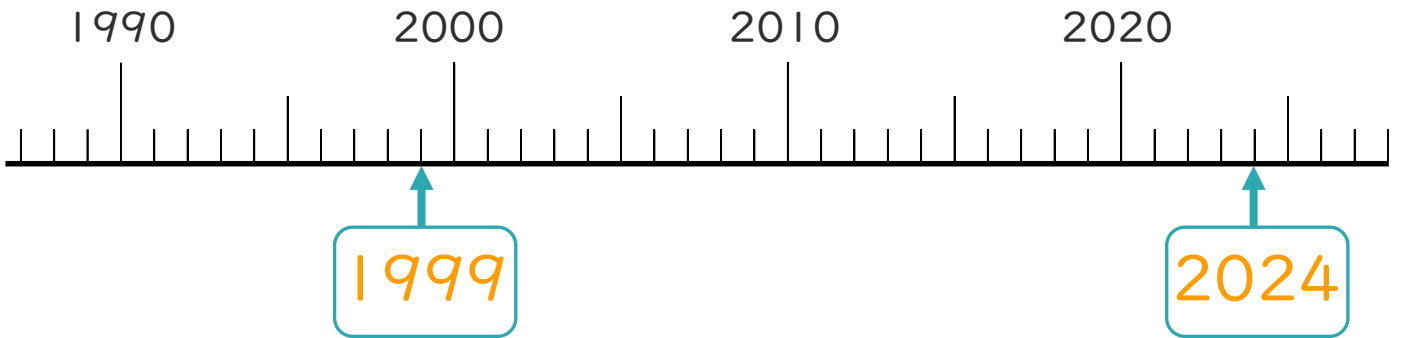

2 次の数を表すめもりに、↑ を書きましょう。

- ① 600 ② 3100

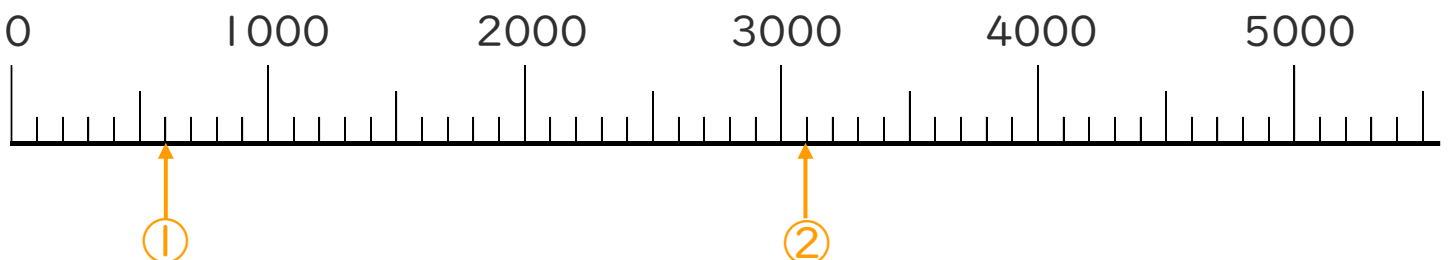

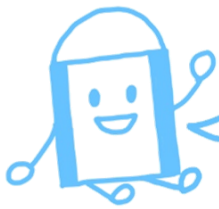

4けたの数 13

◎ いくつずつふえているかな



日にち： 月 日

名まえ _____

1 □ にあう数を書きましょう。

①



②

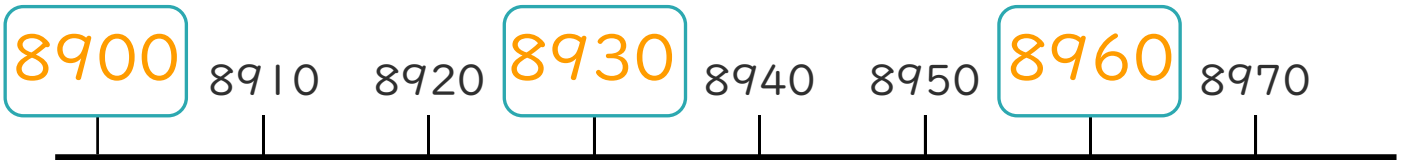

③

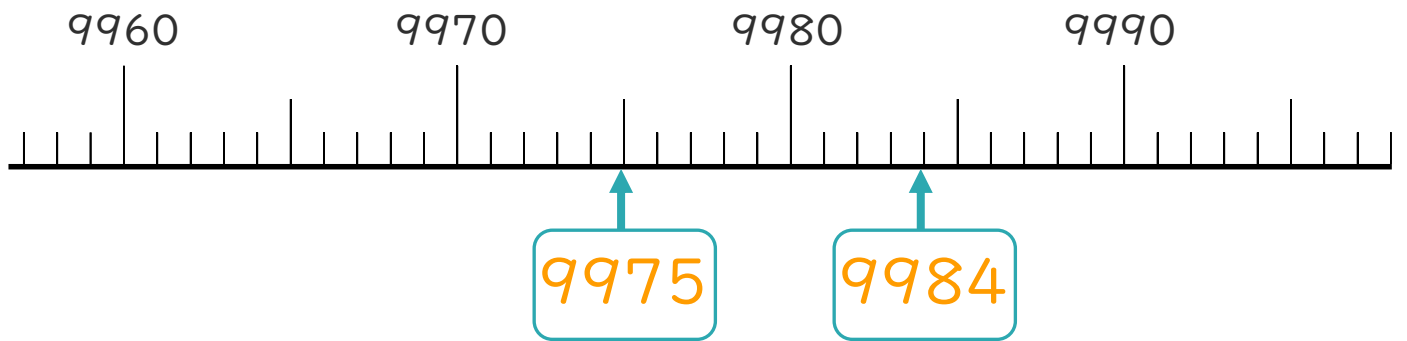

2 次の数を表すめもりに、↑ を書きましょう。

① 5500 ② 7700

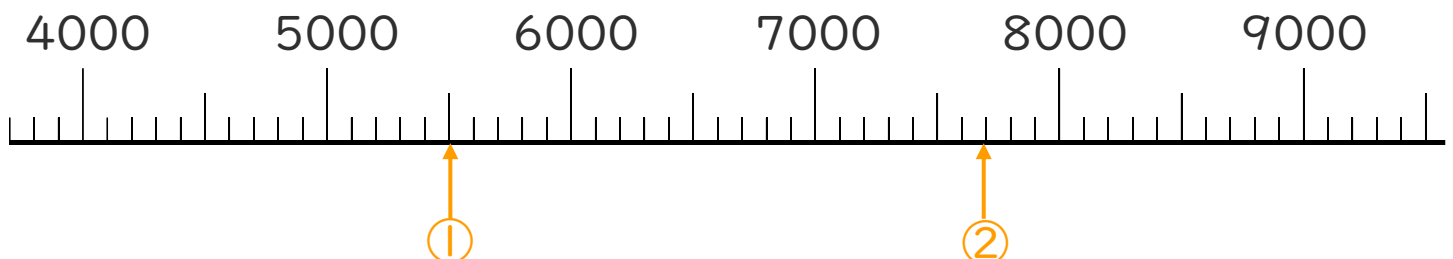



4けたの数 13

◎ いくつずつふえているかな



日にち： 月 日

名まえ _____

1 □ にあう数を書きましょう。

①

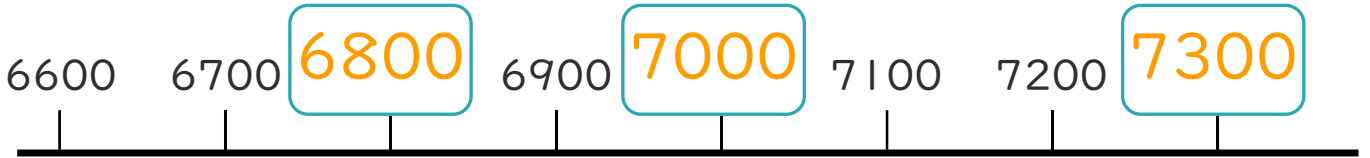

②



③

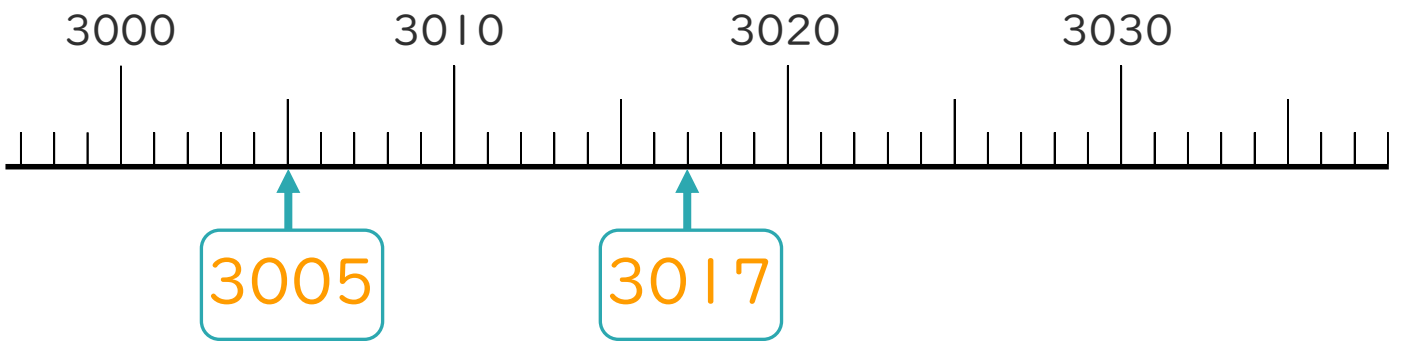

2 次の数を表すめもりに、↑ を書きましょう。

① 900 ② 2600

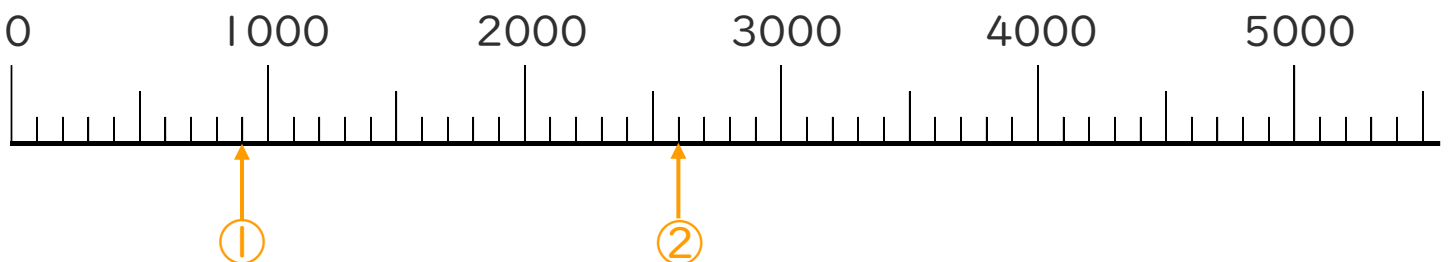

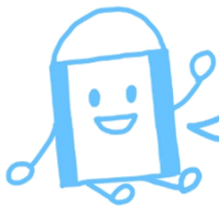

4けたの数 13

◎ いくつずつふえているかな



めざせ90点!



てん

名まえ _____

1 □ にあう数を書きましょう。(各10点)

①

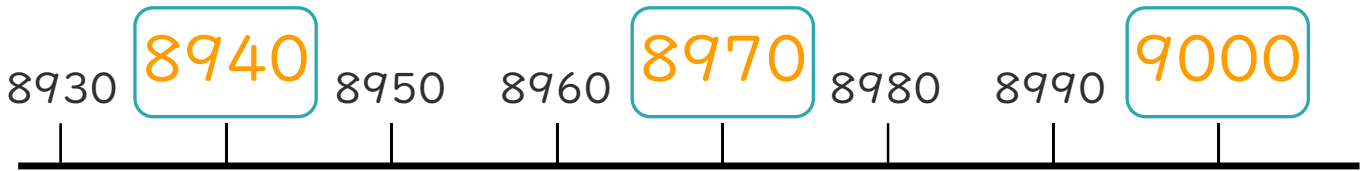

②



③

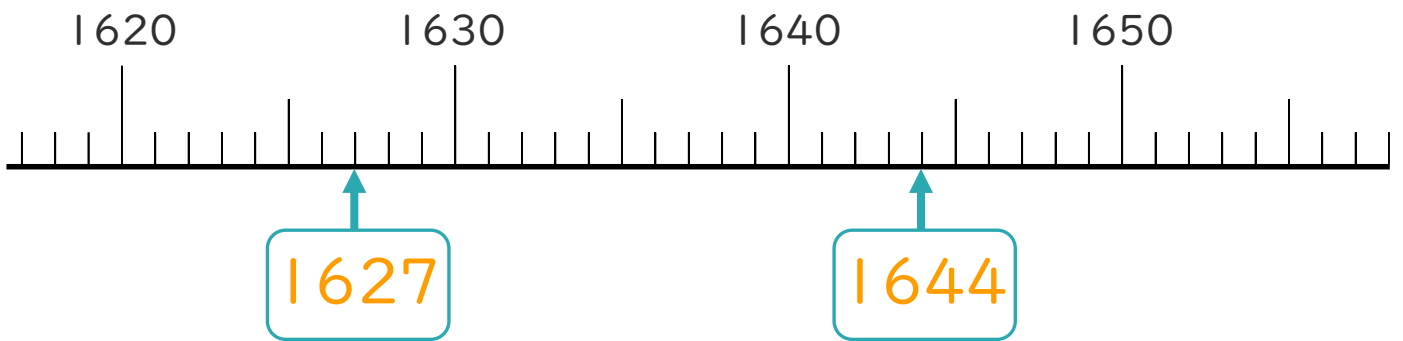

2 次の数を表すめもりに、↑ を書きましょう。(各10点)

① 600 ② 3200

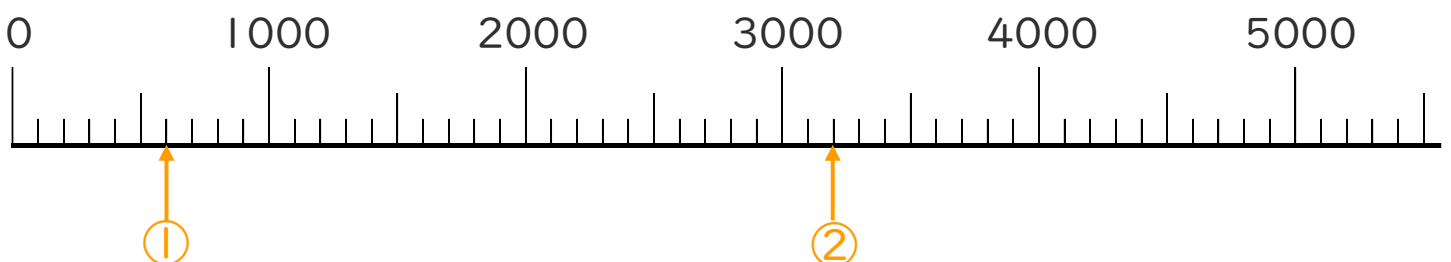

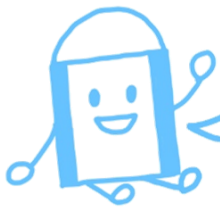

4けたの数 13

◎ いくつずつふえているかな

16

めざせ90点!



てん

名まえ _____

1 □ にあう数を書きましょう。(各10点)

①

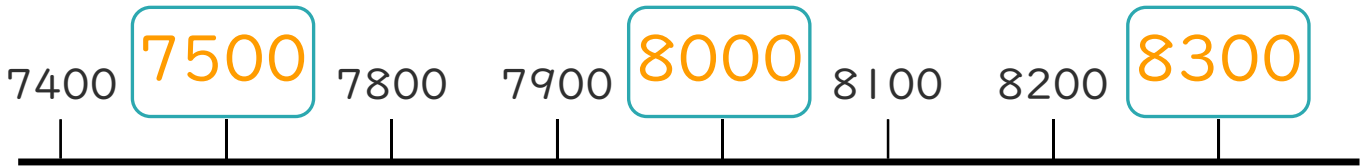

②

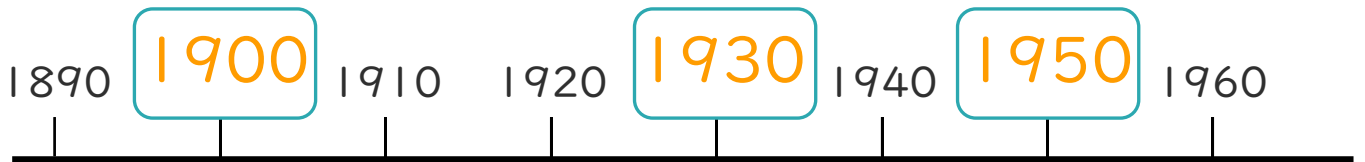

③

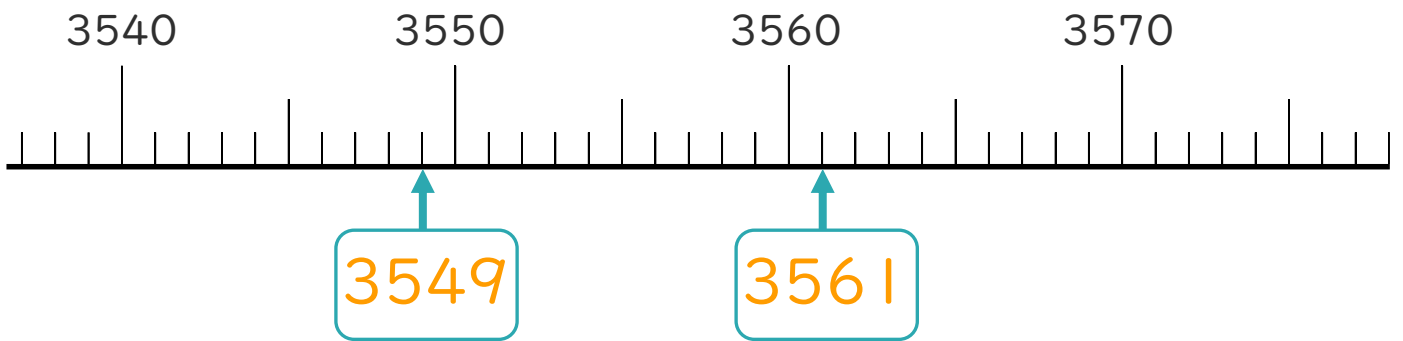

2 次の数を表すめもりに、↑ を書きましょう。(各10点)

① 5900 ② 8200

