



垂直、平行と
四角形 16

●コンパスを使って
ひし形をかく



日にち： 月 日

名まえ _____

1 コンパスを使って、ひし形ABCDをかきましょう。

①

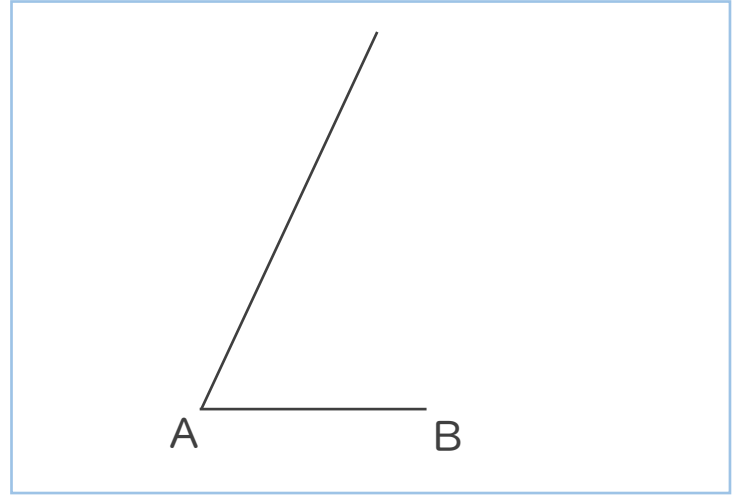
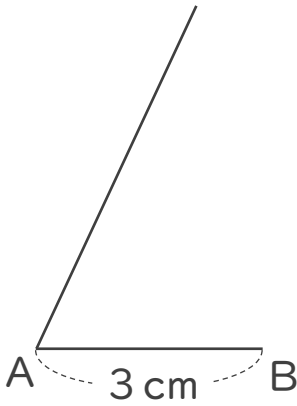

②

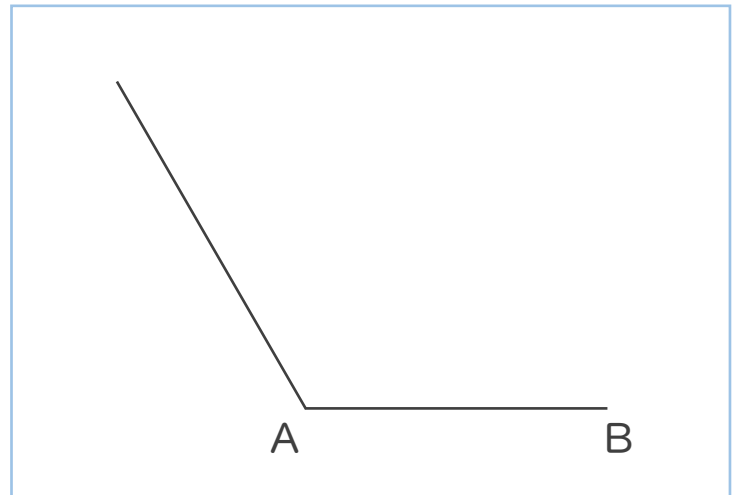
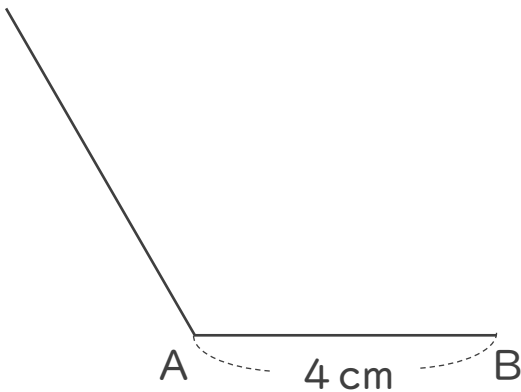

2 次の平行四辺形ABCDをかきましょう。

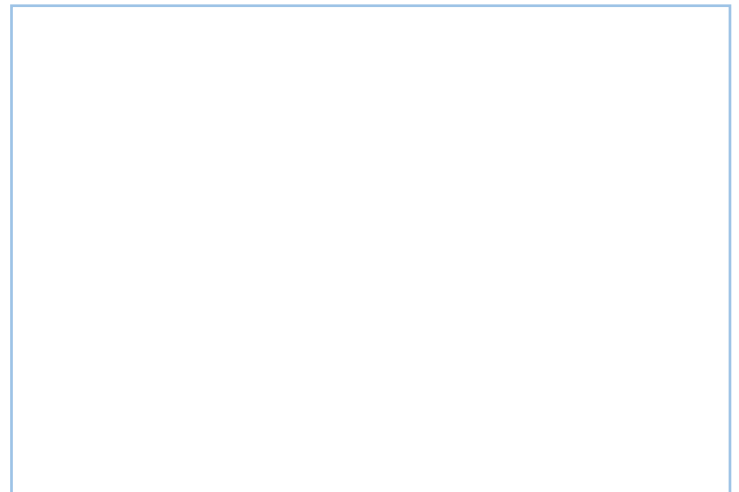
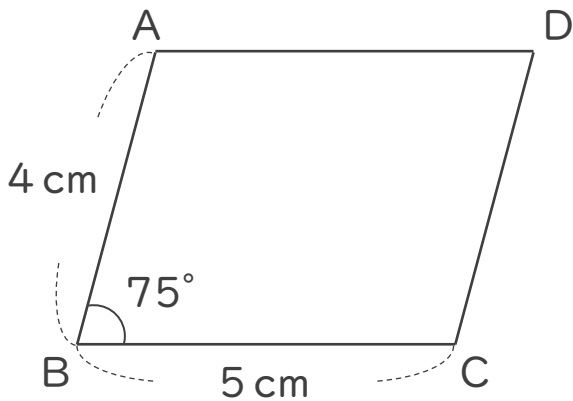

⑩ 仕上げ





垂直、平行と
四角形 16

●コンパスを使って
ひし形をかく



日にち： 月 日

名まえ _____

1 コンパスを使って、ひし形ABCDをかきましょう。

①

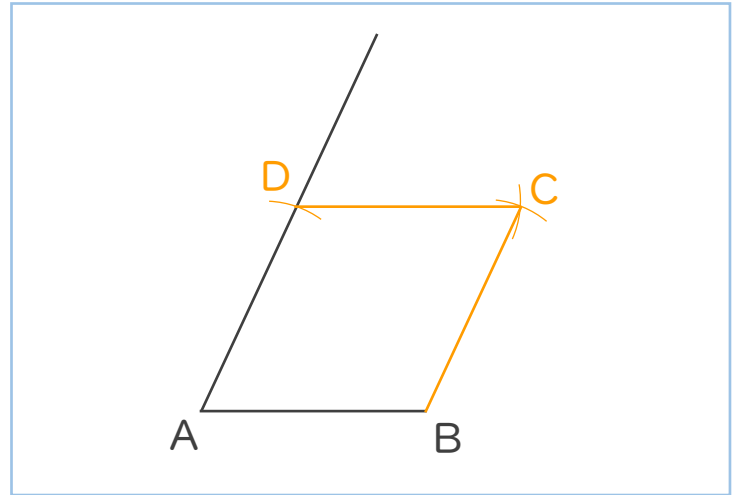
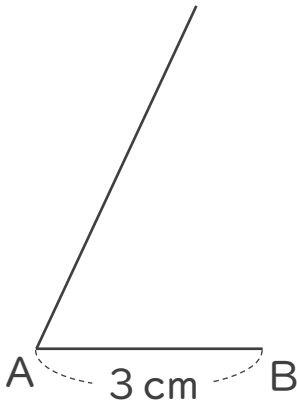

②

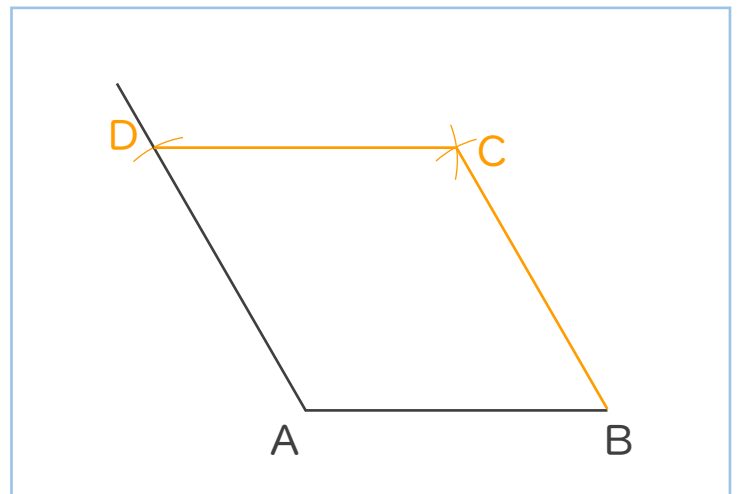
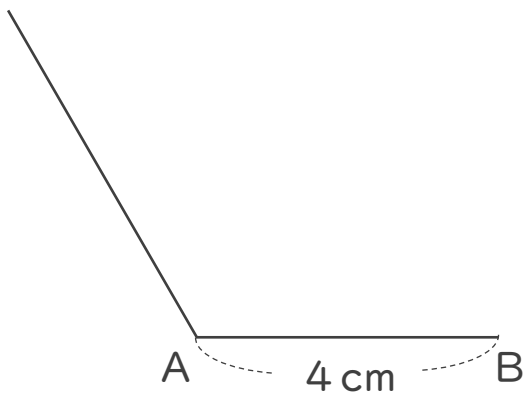

2 次の平行四辺形ABCDをかきましょう。

