

名まえ _____

1 コンパスを使って、ひし形ABCDをかきましょう。(各35点)

①

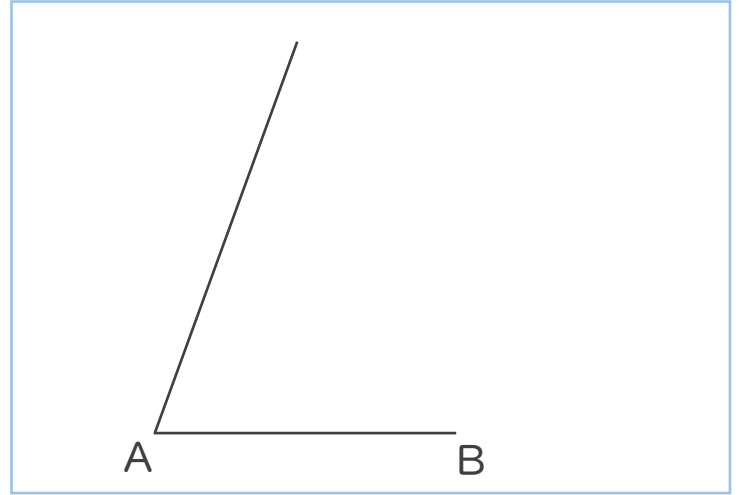
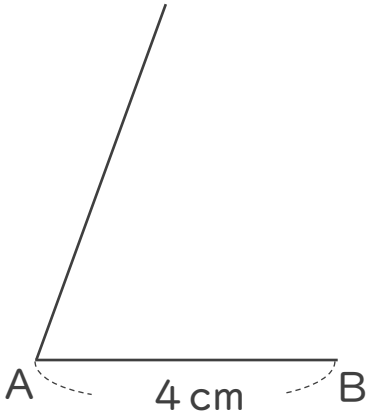

②

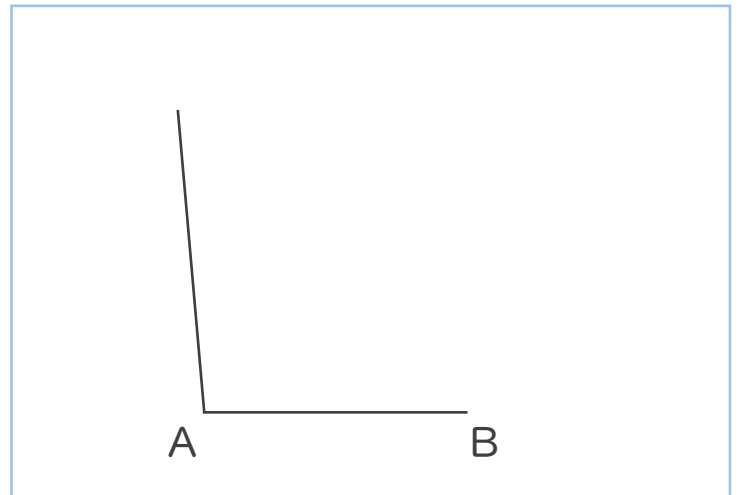
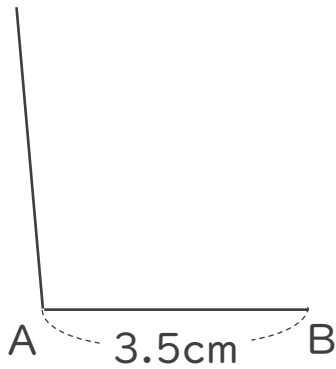

2 次の平行四辺形ABCDをかきましょう。(30点)

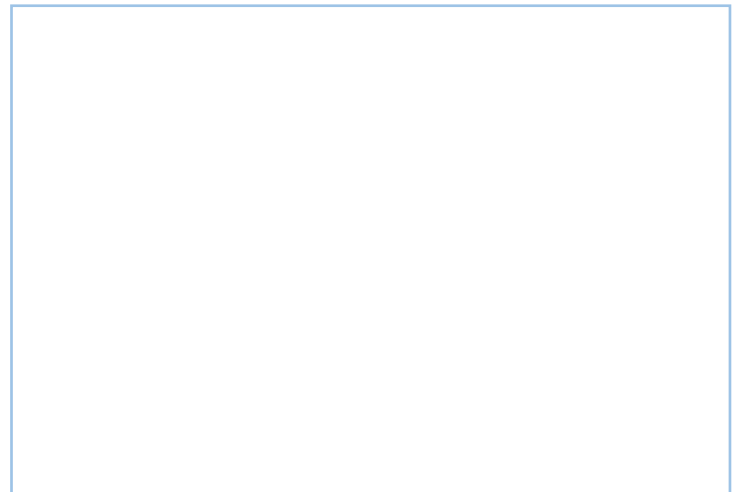
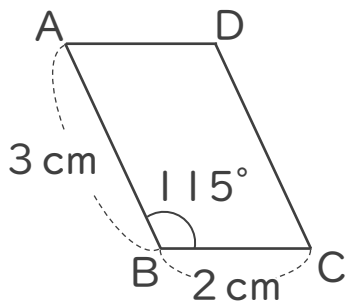



名まえ _____

1 コンパスを使って、ひし形ABCDをかきましょう。(各35点)

①

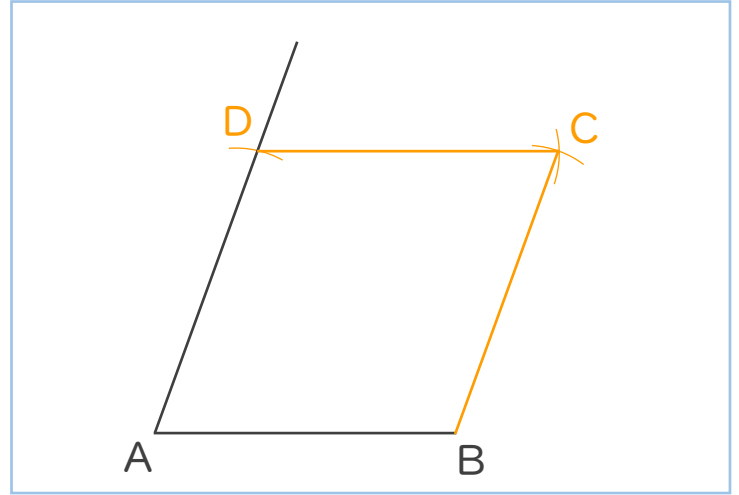
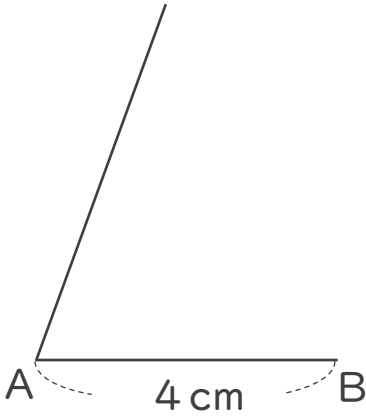

②

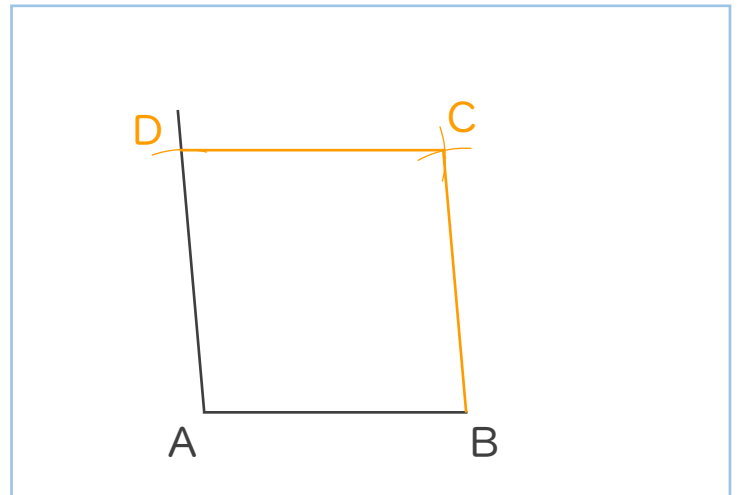
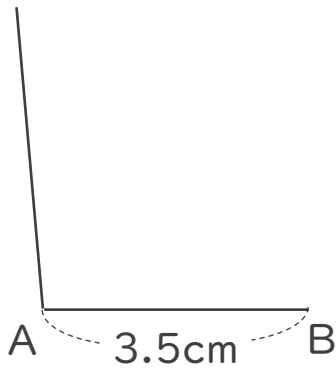

2 次の平行四辺形ABCDをかきましょう。(30点)

