

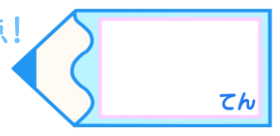

直方体や立方体 14 15

● 見取り図を書く

目指せ100点!



名まえ _____

1 次の図に線を加えて、見取り図を完成させましょう。(各25点)

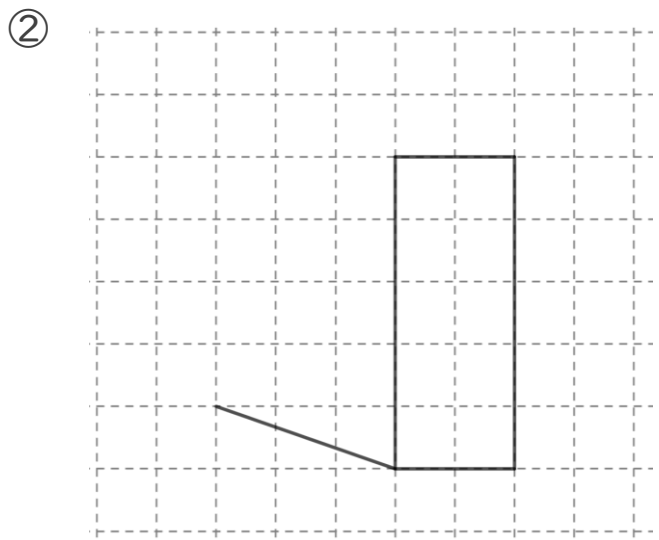
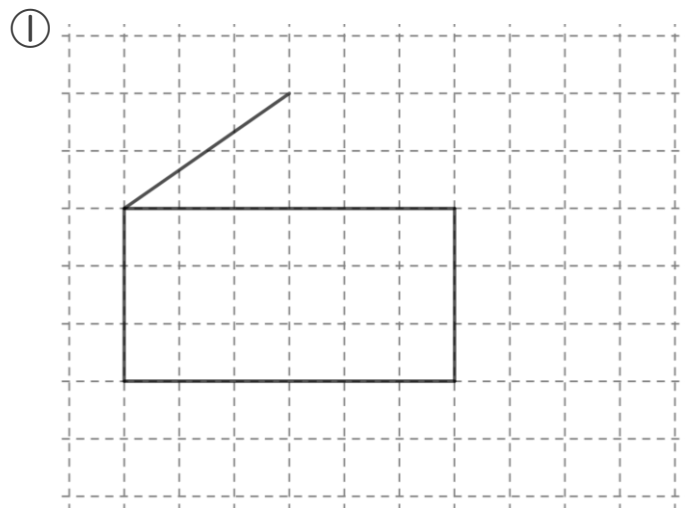

2 次の直方体の見取り図をかいています。続きをかいて、見取り図を完成させましょう。(各25点)

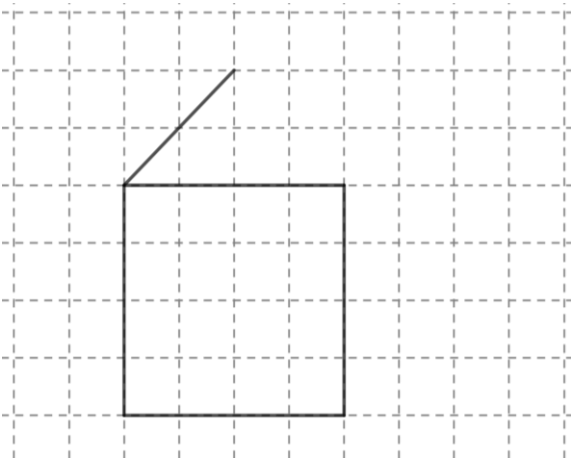
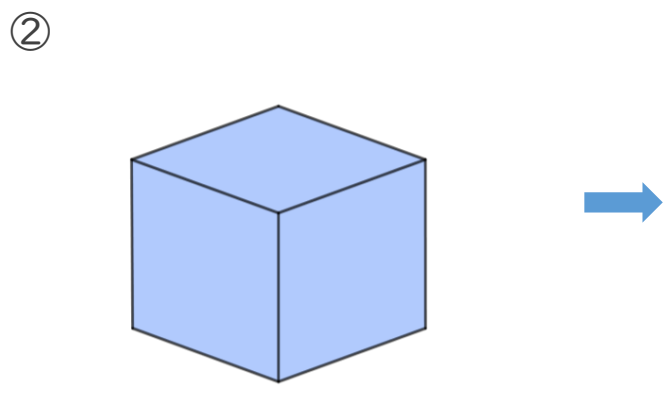
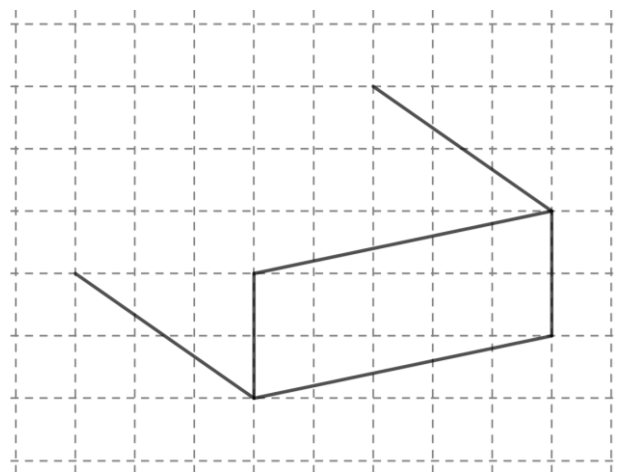
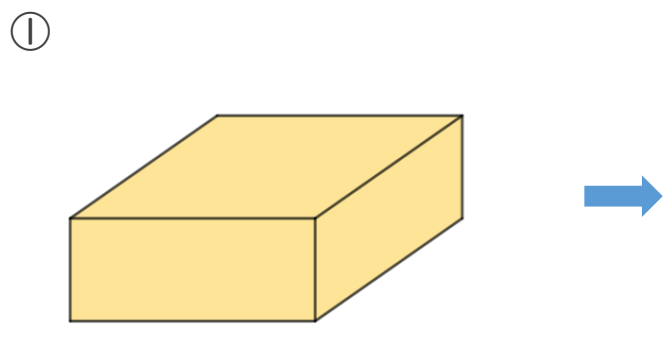



直方体や立方体 14 15

● 見取り図を書く

目指せ100点!

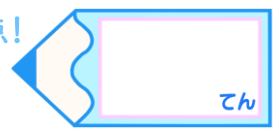

名まえ _____

1 次の図に線を加えて、見取り図を完成させましょう。(各25点)

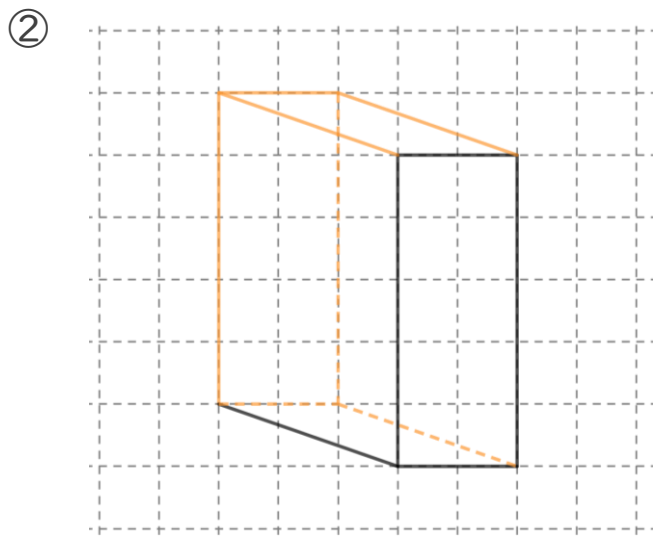
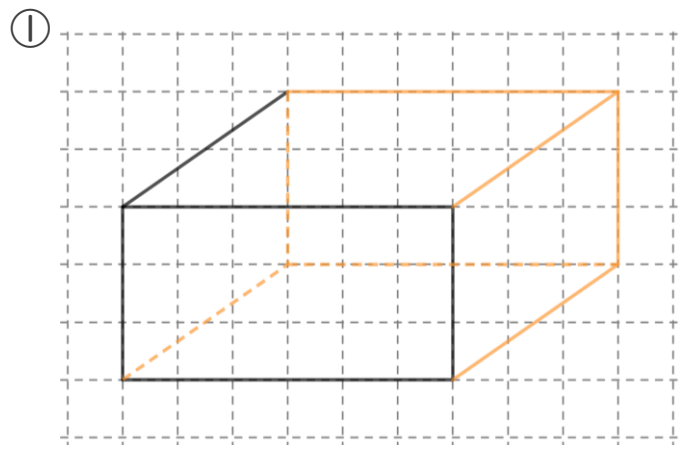

2 次の直方体の見取り図をかいています。続きをかいて、見取り図を完成させましょう。(各25点)

