



垂直、平行と
四角形 16

●コンパスを使って
ひし形をかく



日にち： 月 日

名まえ _____

・コンパスを使って、ひし形ABCDをかきましょう。

①

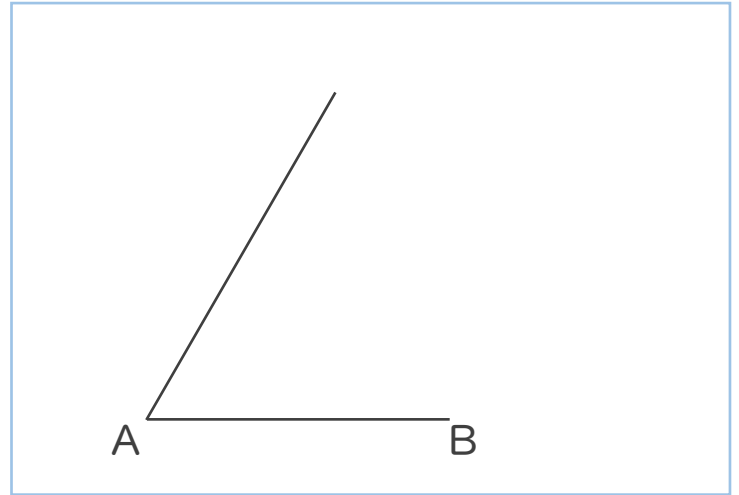
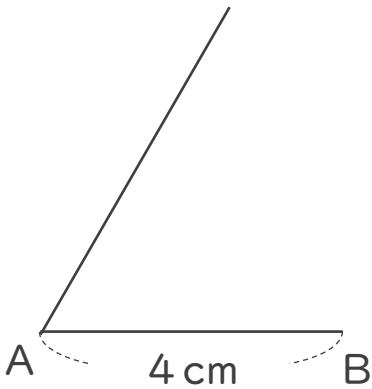

②

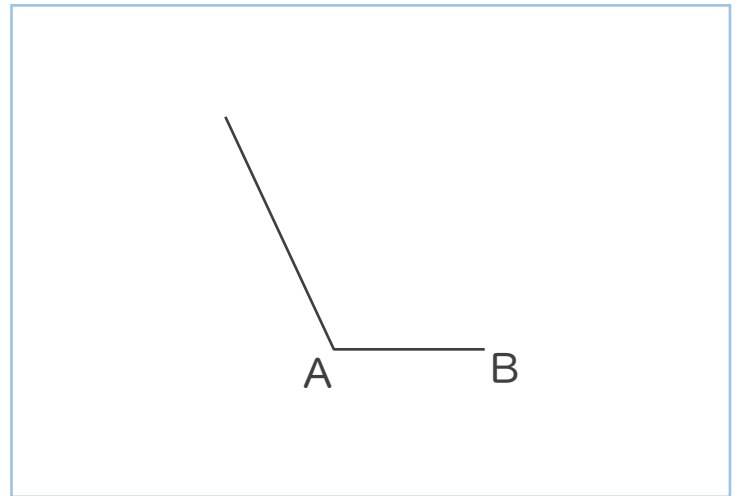
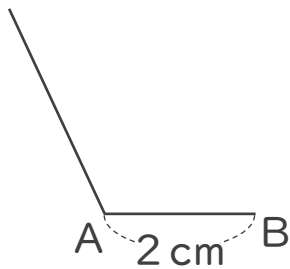

③

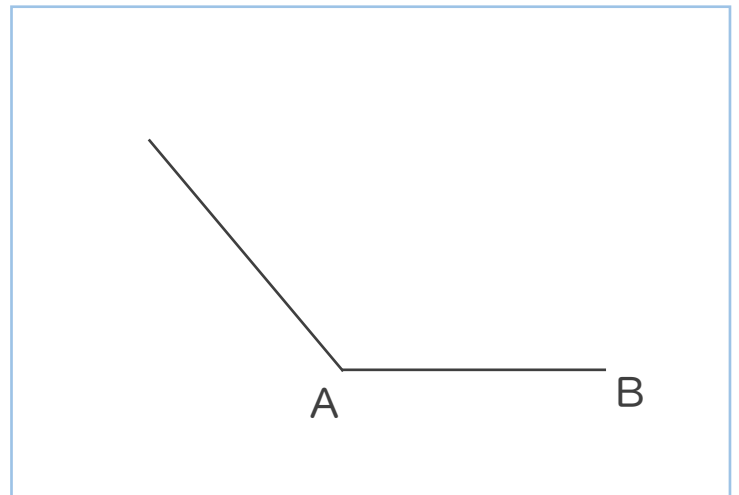
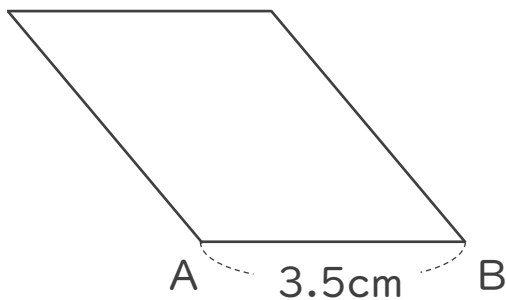

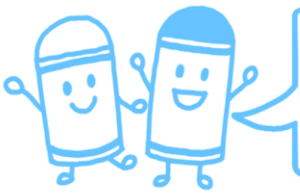

垂直、平行と
四角形 16

●コンパスを使って
ひし形をかく



日にち： 月 日

名まえ _____

・コンパスを使って、ひし形ABCDをかきましょう。

①

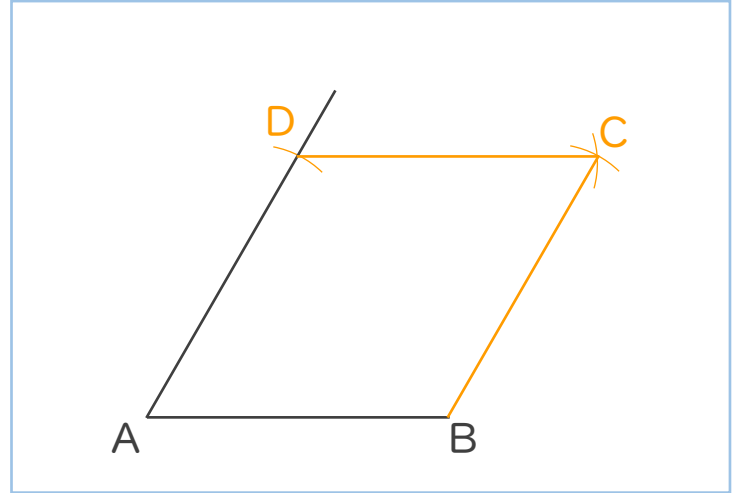
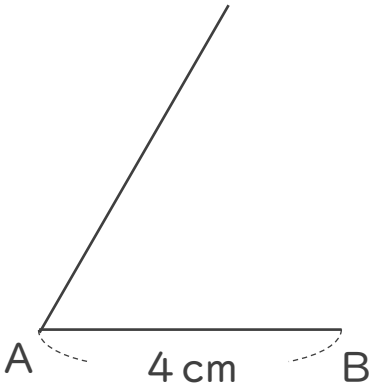

②

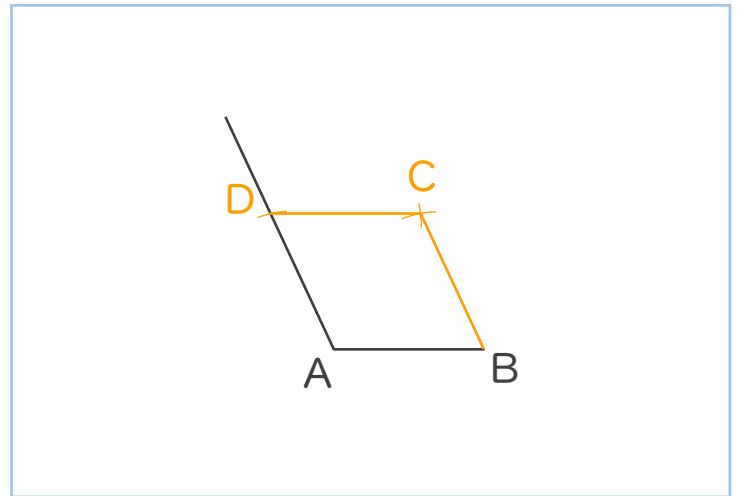
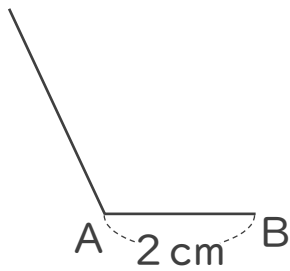

③

