



角柱と円柱 8

◎ 角柱や円柱の見取り図



日にち： 月 日

名まえ _____

・ 次の立体の見取り図をかきましょう。（うすい線はなぞりましょう。）

① 三角柱

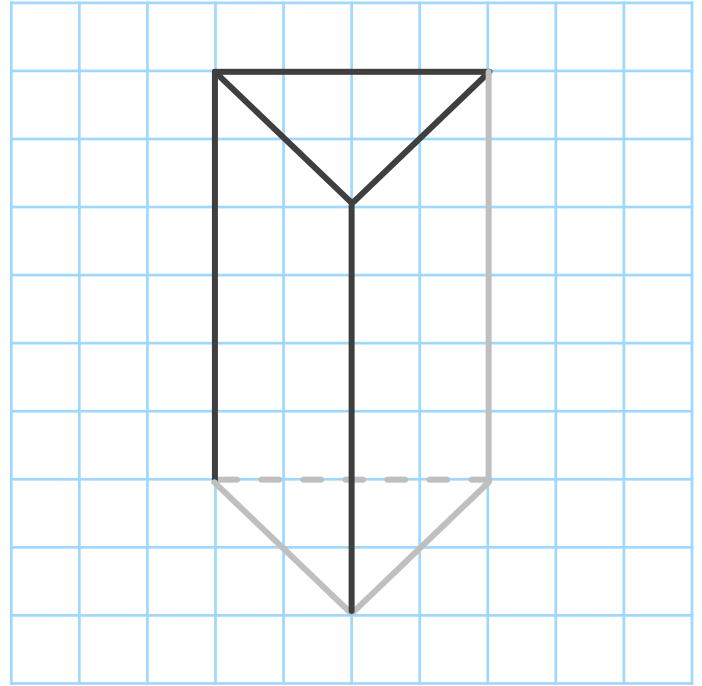
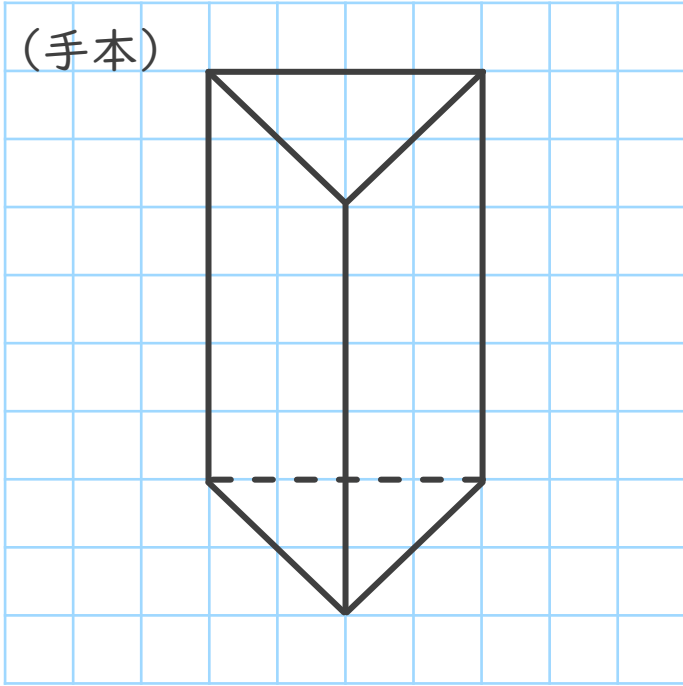

見えない辺は点線でかくよ！



② 円柱

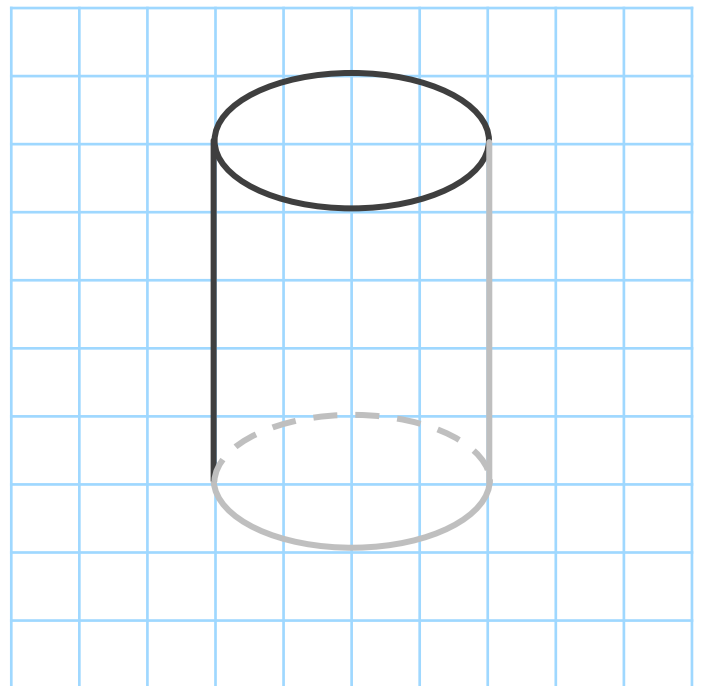
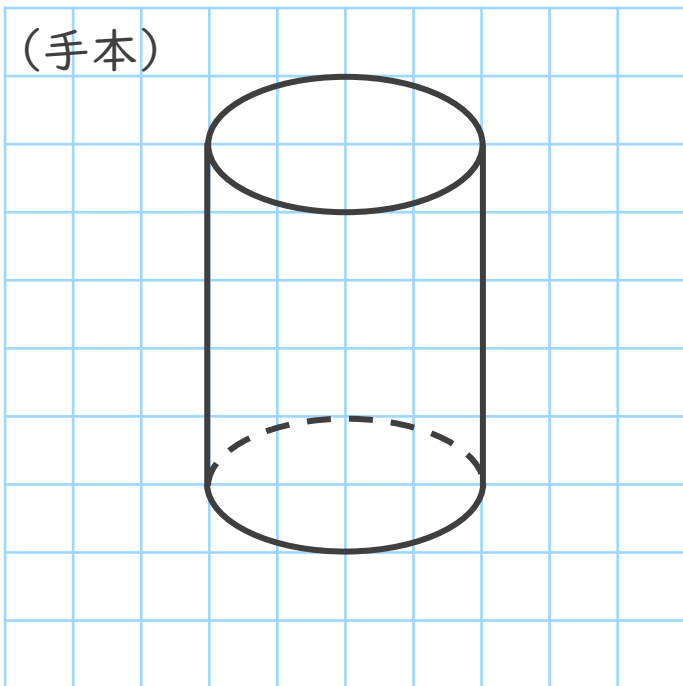



角柱と円柱 8

● 角柱や円柱の見取り図



日にち： 月 日

名まえ _____

・ 次の立体の見取り図をかきましょう。（うすい線はなぞりましょう。）

① 円柱

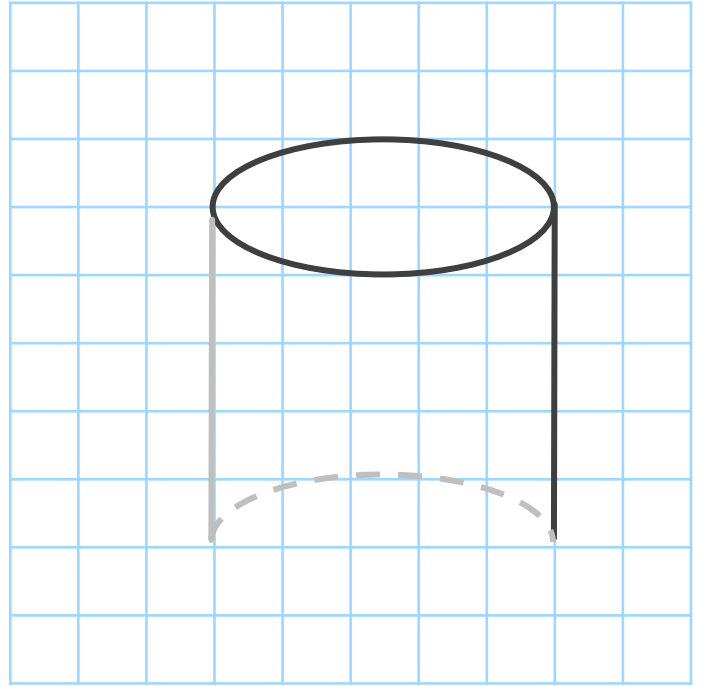
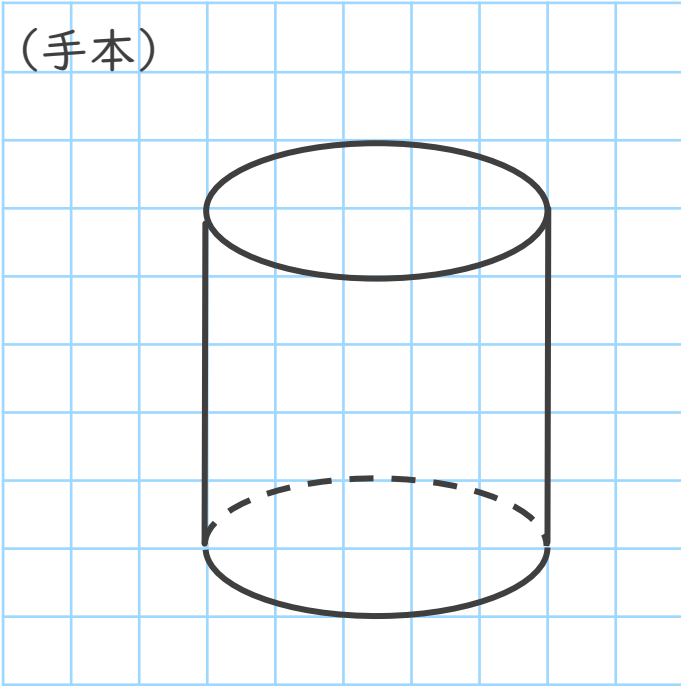

見えない辺は点線でかくよ！



② 四角柱

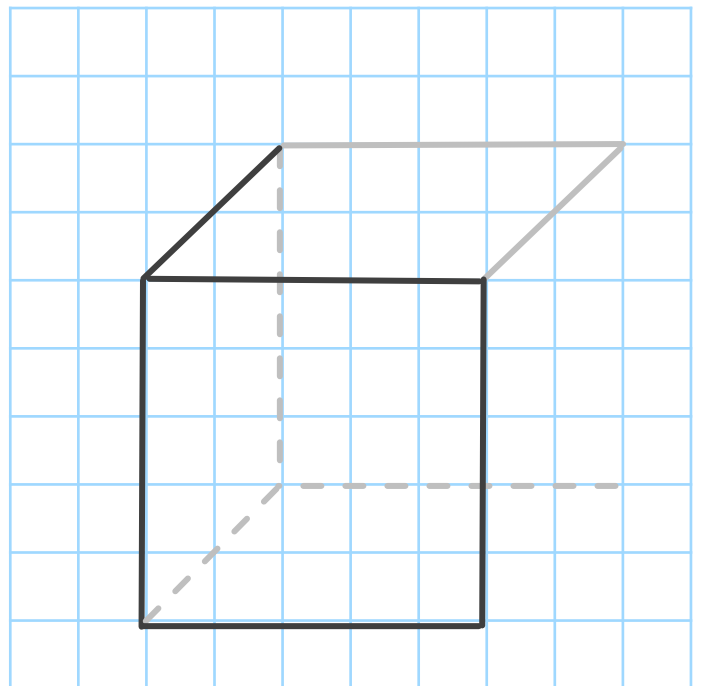
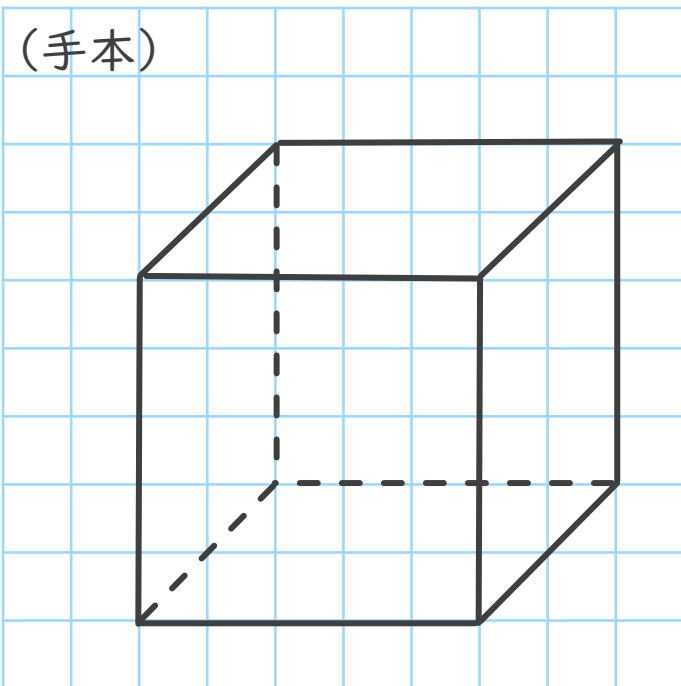



角柱と円柱 8

◎ 角柱や円柱の見取り図



日にち： 月 日

名まえ _____

・ 次の立体の見取り図をかきましょう。（うすい線はなぞりましょう。）

① 三角柱

(手本)

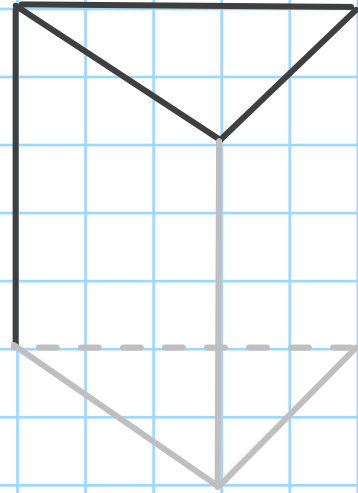
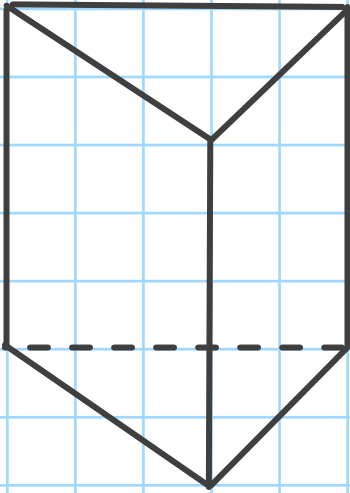

見えない辺は点線でかくよ！



② 円柱

(手本)

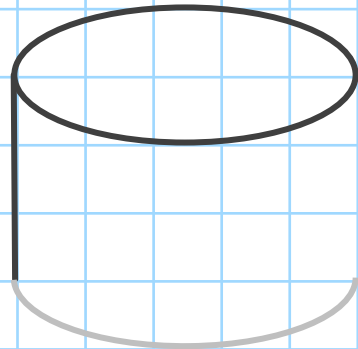
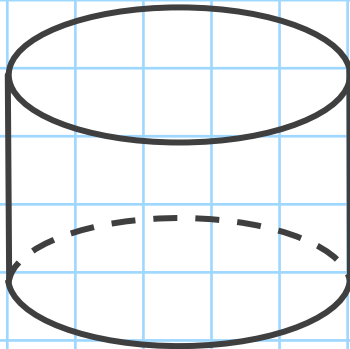

③ 確認





角柱と円柱 8

● 角柱や円柱の見取り図



日にち： 月 日

名まえ _____

・ 次の立体の見取り図をかきましょう。（うすい線はなぞりましょう。）

① 円柱

(手本)

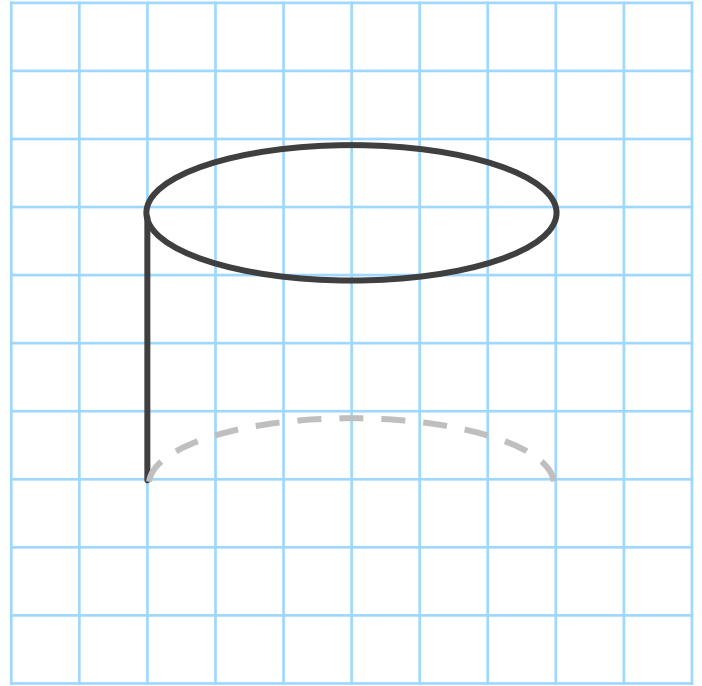
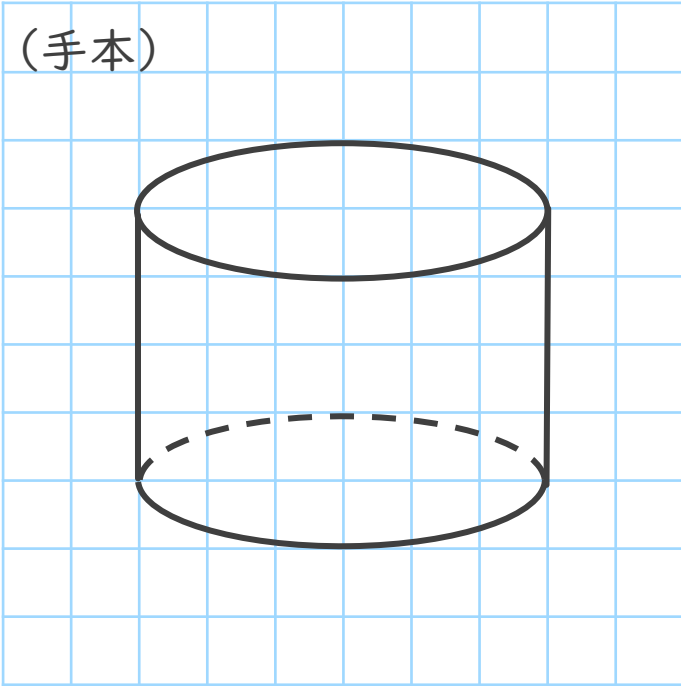

見えない辺は点線でかくよ！



② 四角柱

(手本)

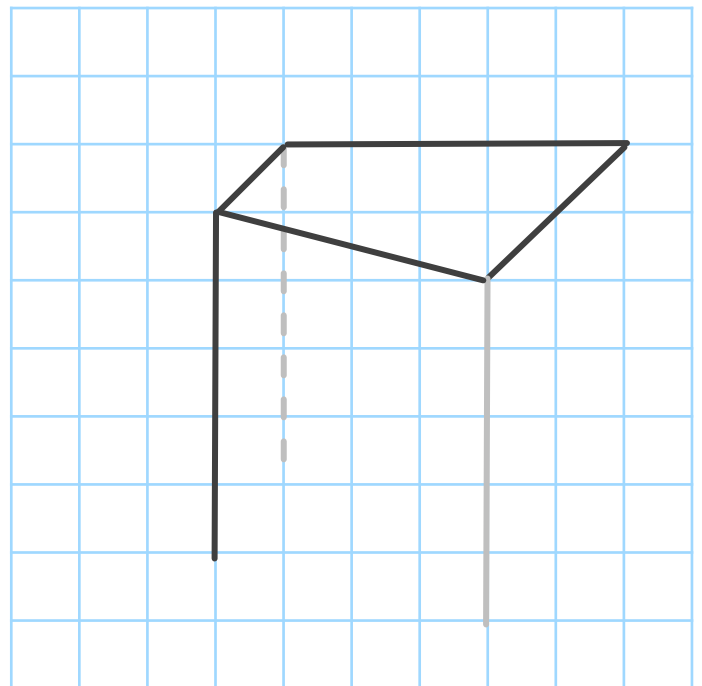
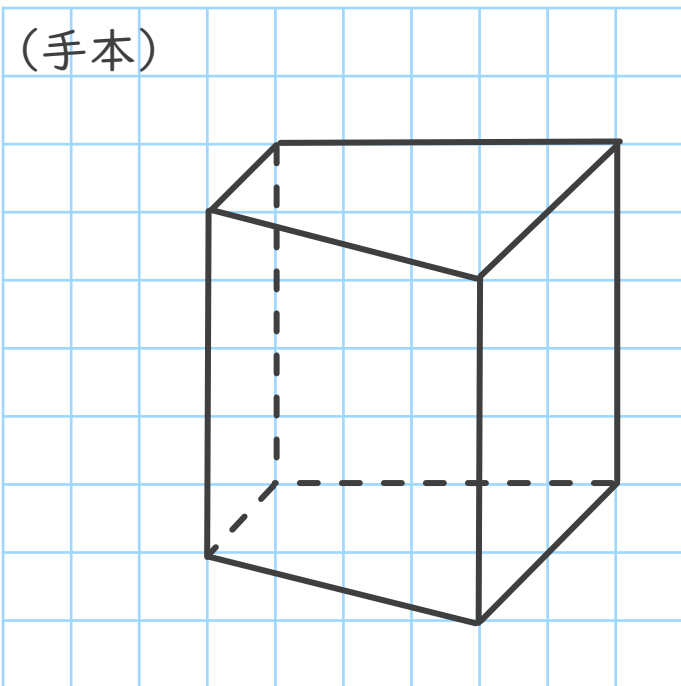



角柱と円柱 8

◎ 角柱や円柱の見取り図



日にち： 月 日

名まえ _____

・ 次の立体の見取り図をかきましょう。（うすい線はなぞりましょう。）

① 四角柱

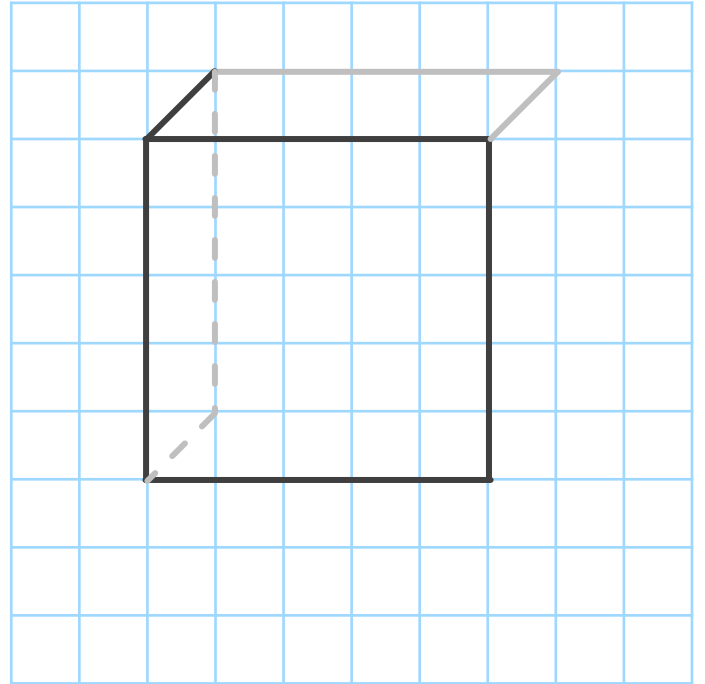
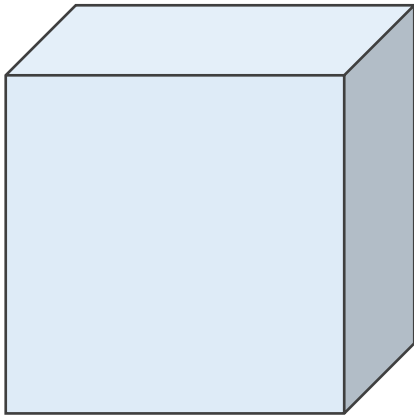

② 円柱

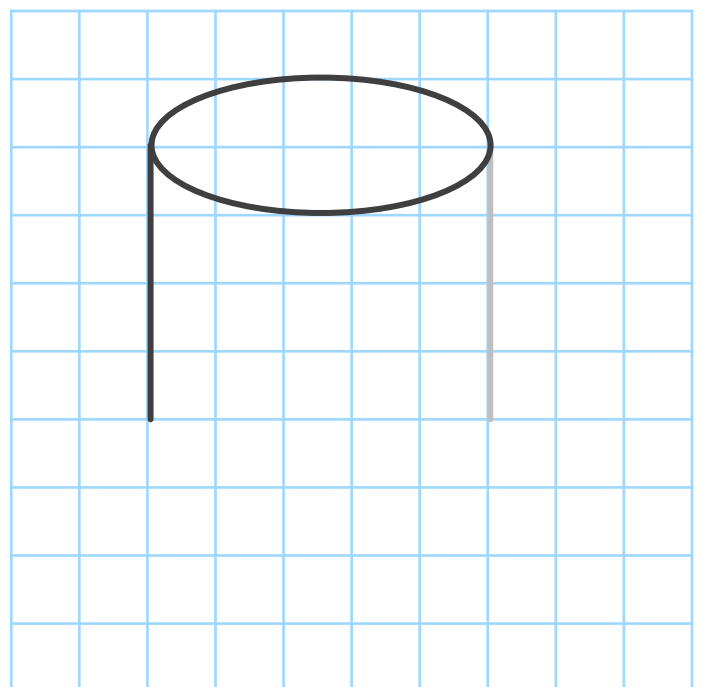
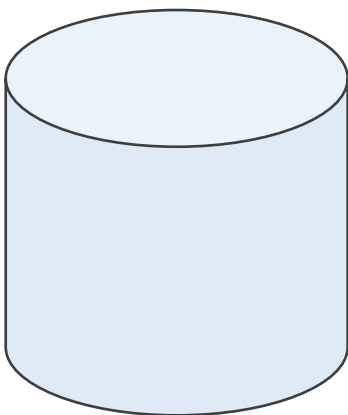



角柱と円柱 8

◎ 角柱や円柱の見取り図



日にち： 月 日

名まえ _____

・ 次の立体の見取り図をかきましょう。（うすい線はなぞりましょう。）

① 三角柱

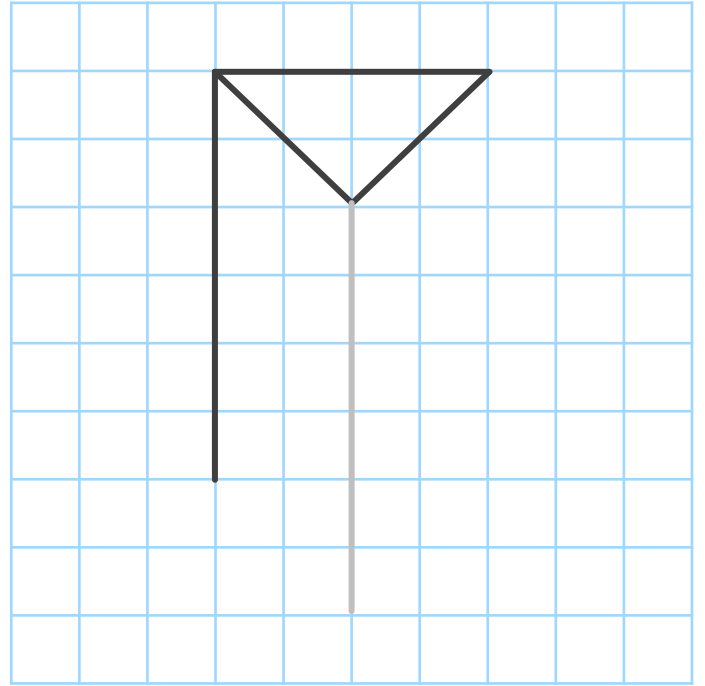
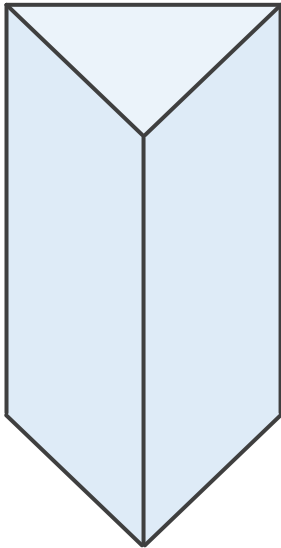

② 円柱

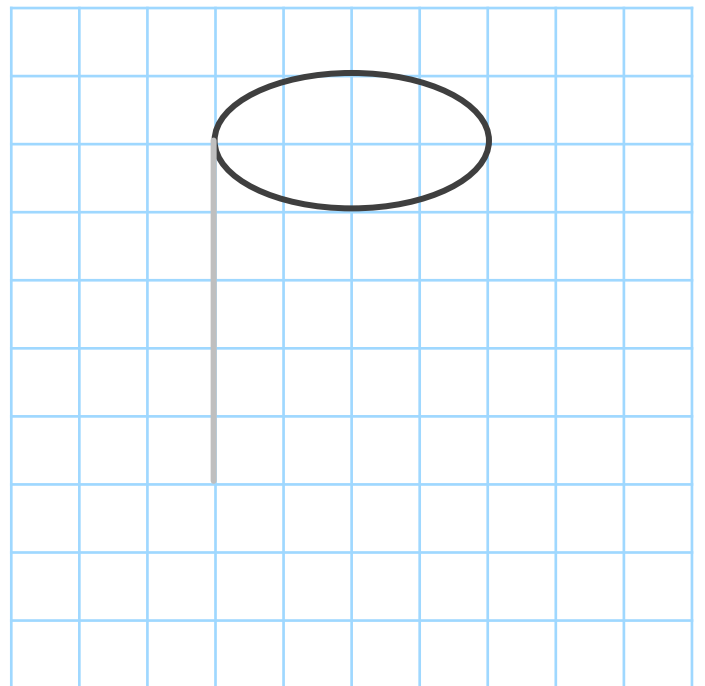
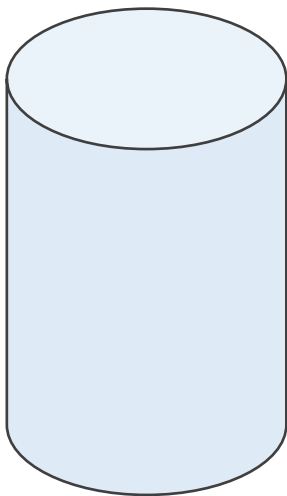



角柱と円柱 8

◎ 角柱や円柱の見取り図



日にち： 月 日

名まえ _____

・ 次の立体の見取り図をかきましょう。

① 円柱

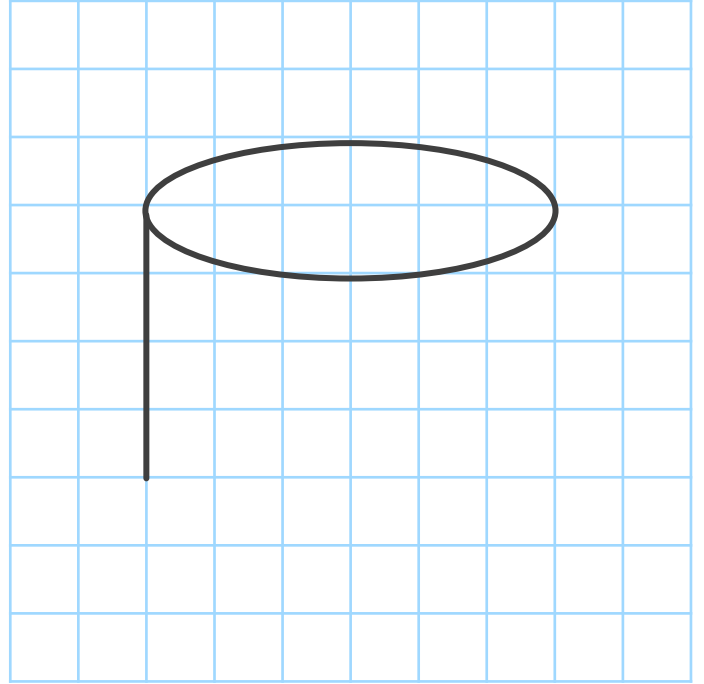
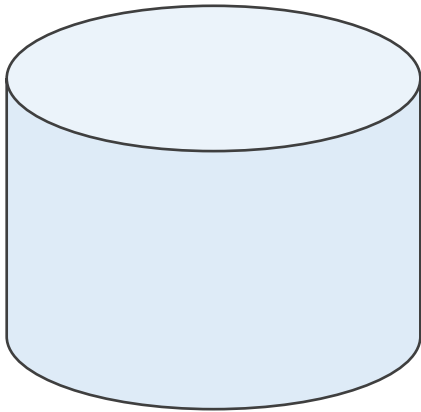

② 四角柱

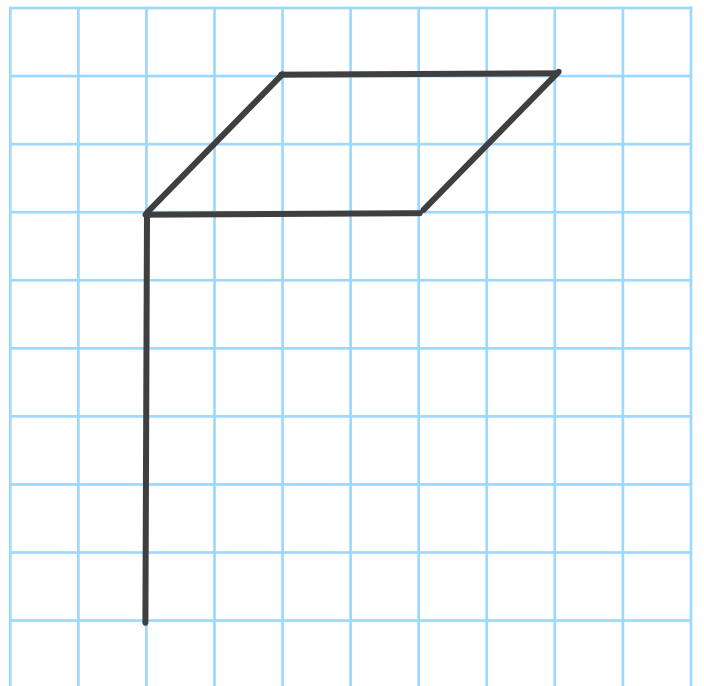
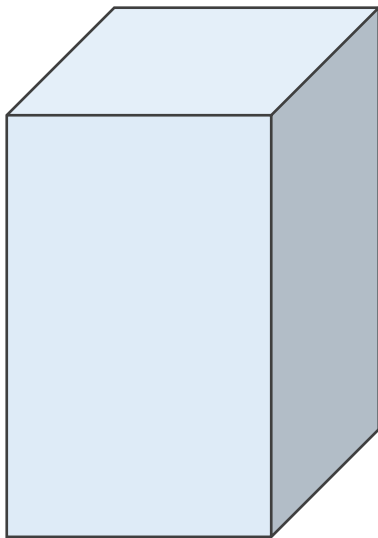



角柱と円柱 8

◎ 角柱や円柱の見取り図



日にち： 月 日

名まえ _____

・ 次の立体の見取り図をかきましょう。

① 三角柱

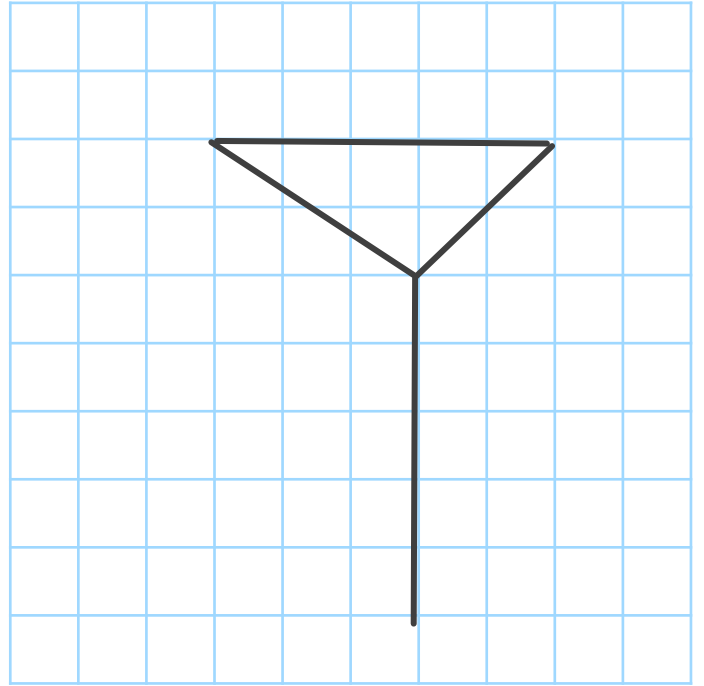
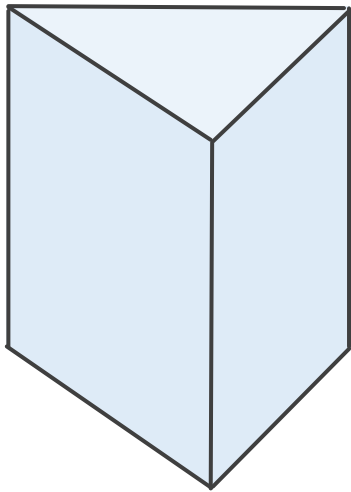

② 円柱

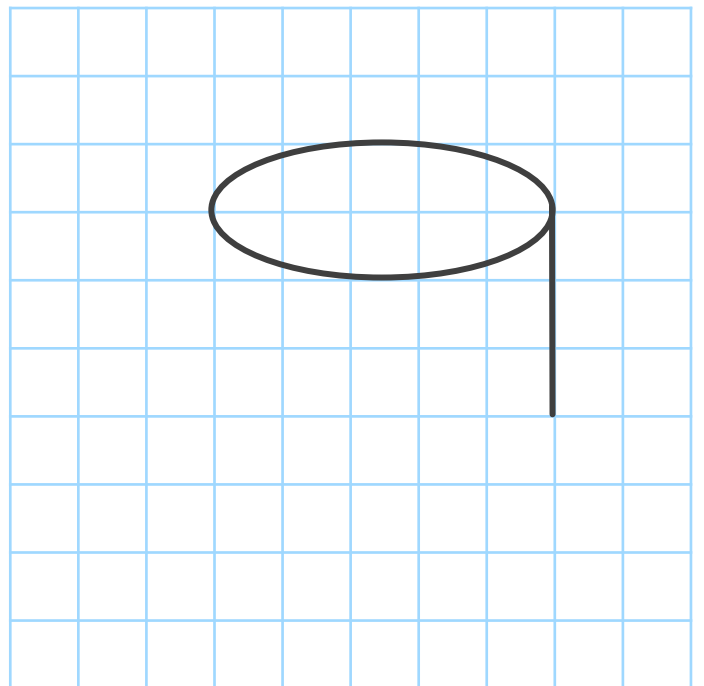
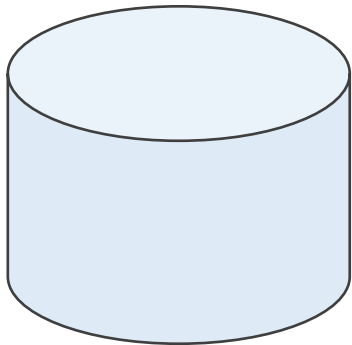



角柱と円柱 8

◎ 角柱や円柱の見取り図



日にち： 月 日

名まえ _____

・ 次の立体の見取り図をかきましょう。

① 円柱

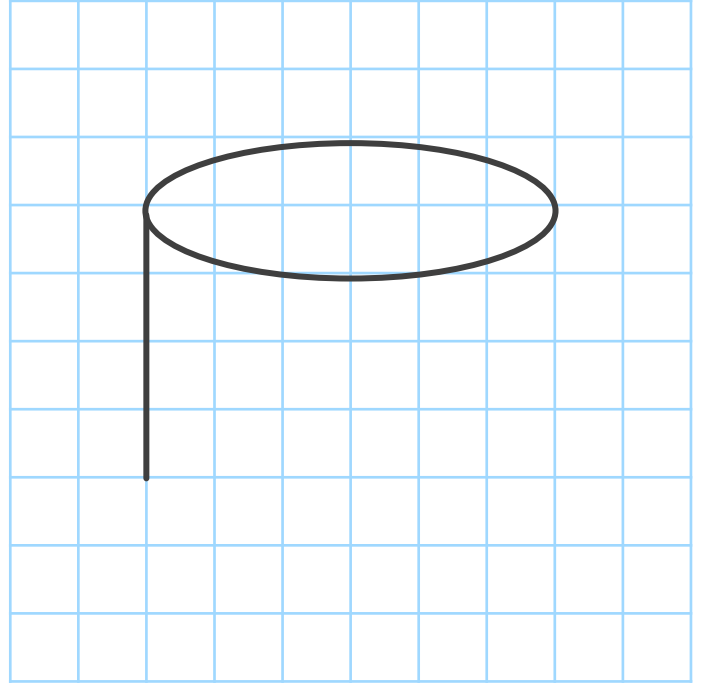
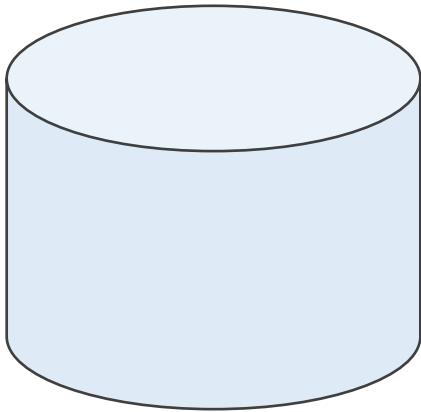

② 四角柱

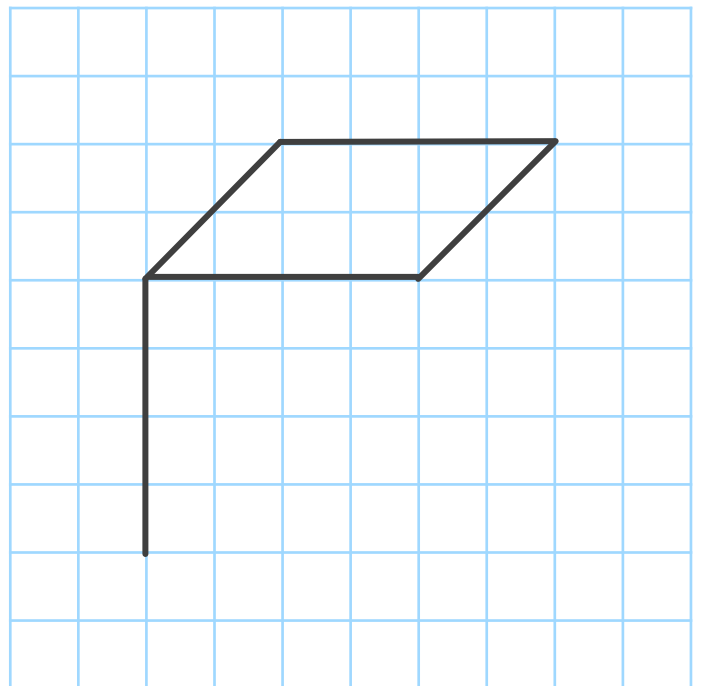
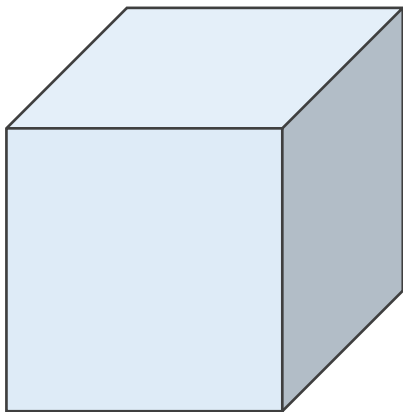



角柱と円柱 8

◎ 角柱や円柱の見取り図



日にち： 月 日

名まえ _____

・ 次の立体の見取り図をかきましょう。（うすい線はなぞりましょう。）

① 三角柱

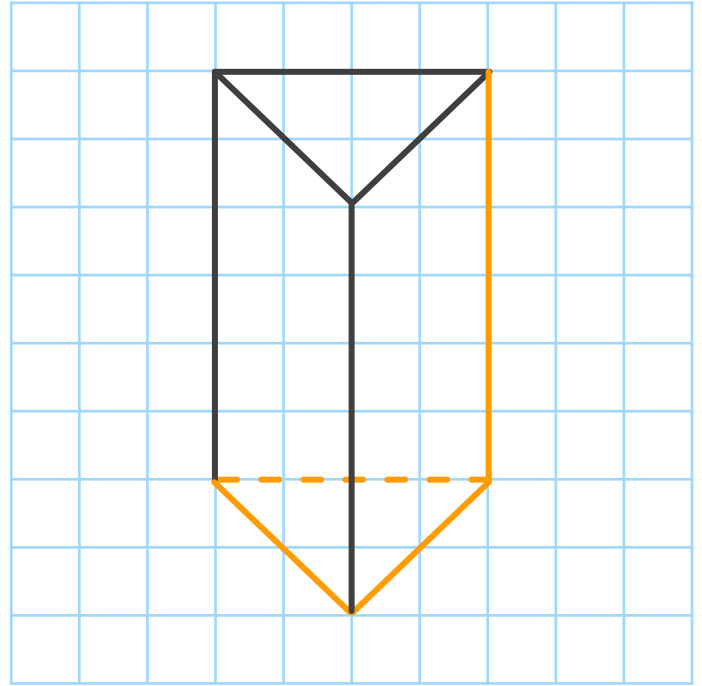
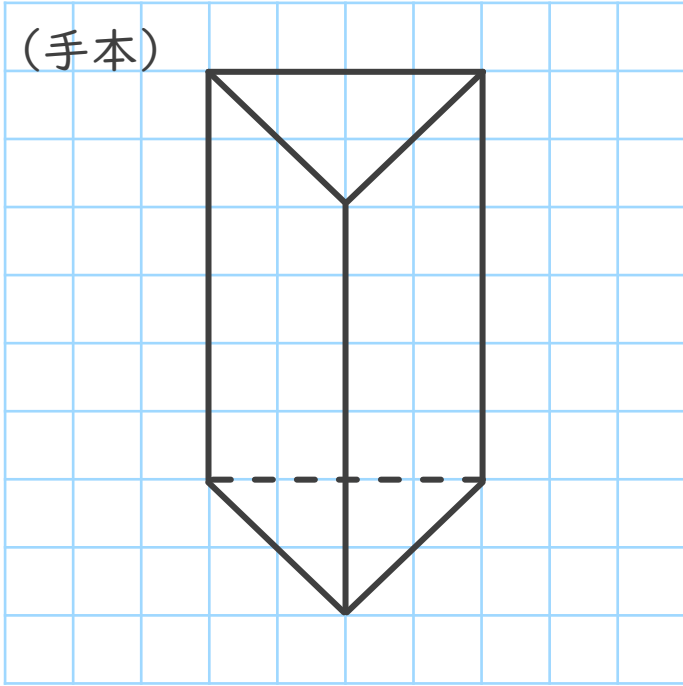

見えない辺は点線でかくよ！



② 円柱

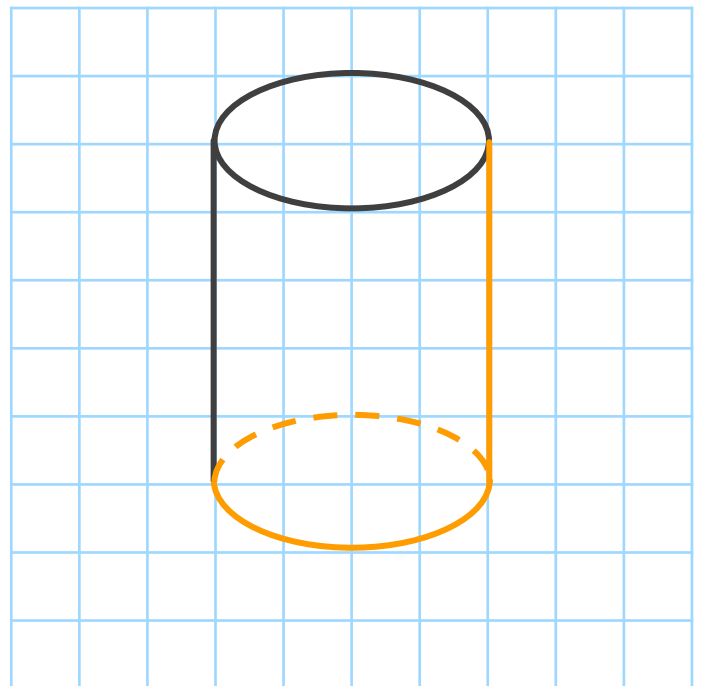
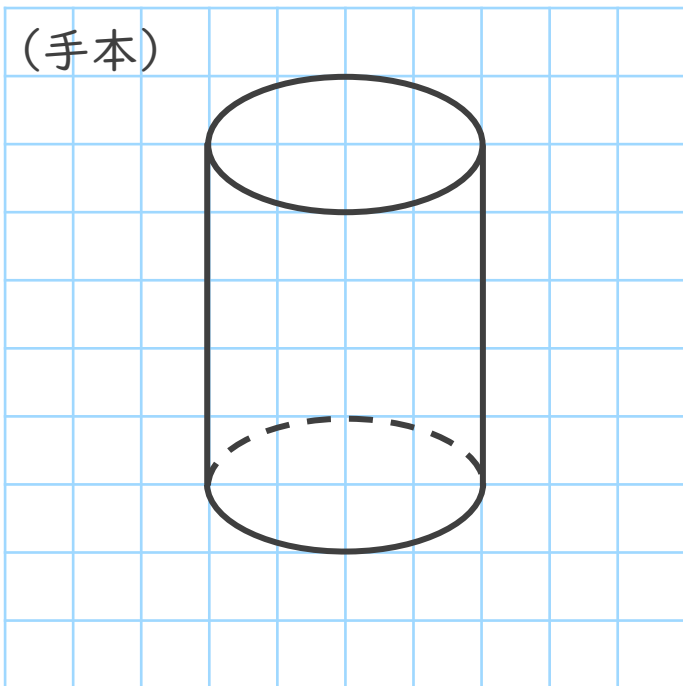



角柱と円柱 8

◎ 角柱や円柱の見取り図



日にち： 月 日

名まえ _____

・ 次の立体の見取り図をかきましょう。（うすい線はなぞりましょう。）

① 円柱

(手本)

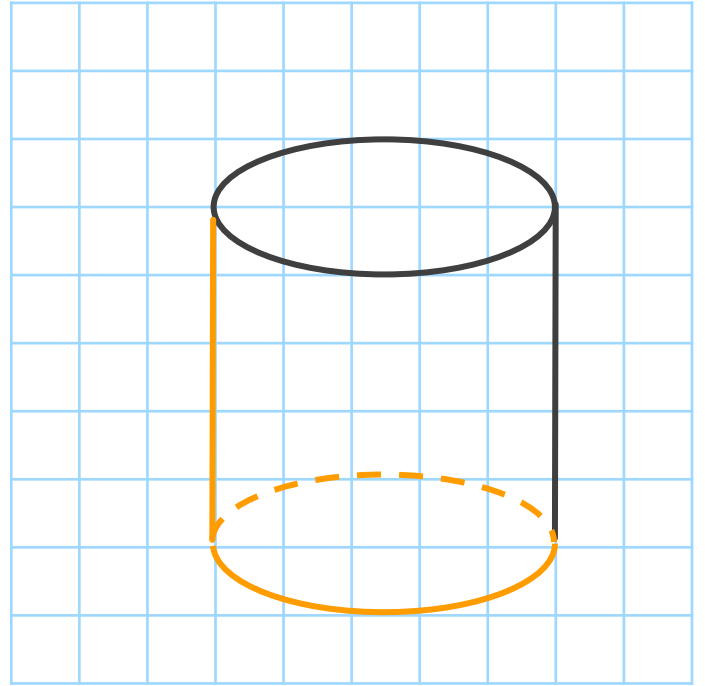
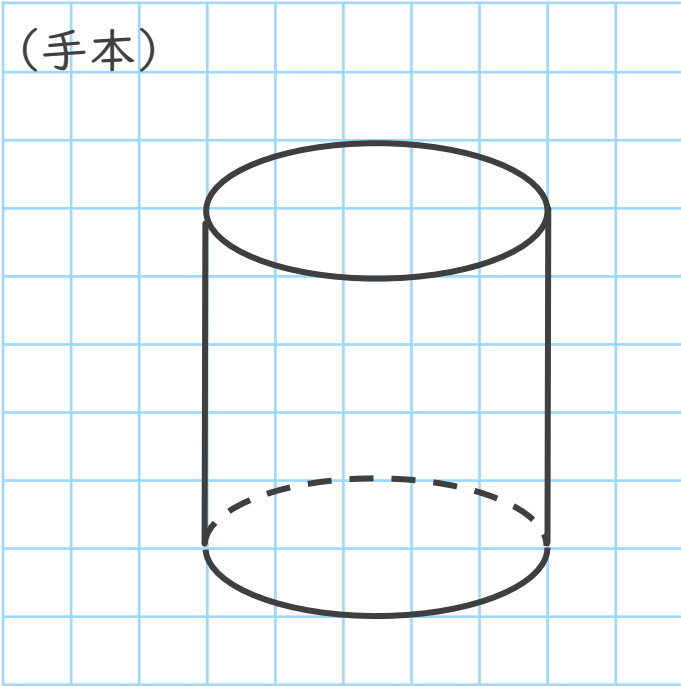

見えない辺は点線でかくよ！



② 四角柱

(手本)

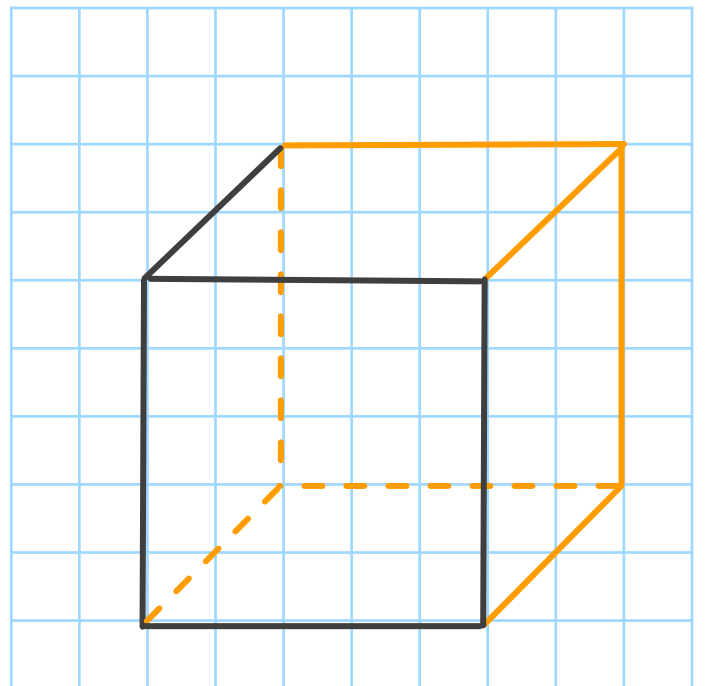
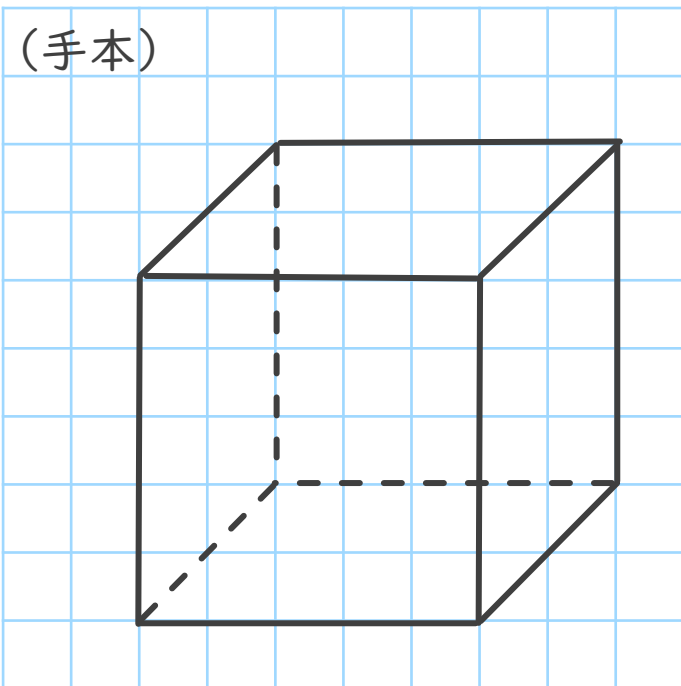



角柱と円柱 8

◎ 角柱や円柱の見取り図



日にち： 月 日

名まえ _____

・ 次の立体の見取り図をかきましょう。(うすい線はなぞりましょう。)

① 三角柱

(手本)

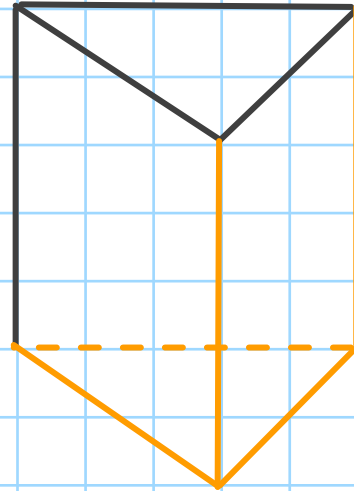
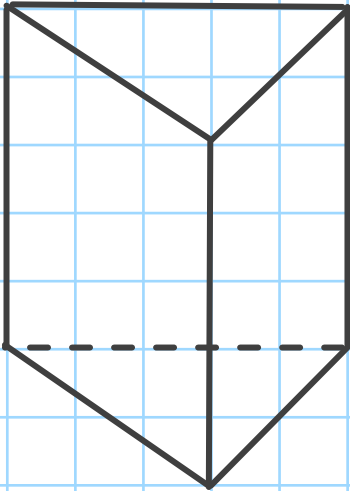

見えない辺は点線でかくよ!



② 円柱

(手本)

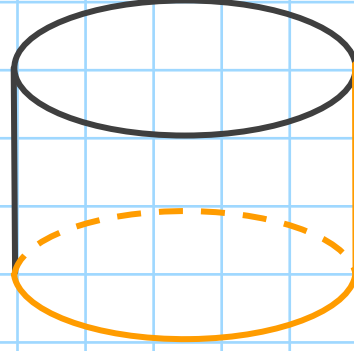
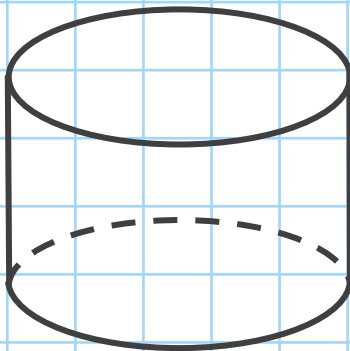



角柱と円柱 8

● 角柱や円柱の見取り図



日にち： 月 日

名まえ _____

・ 次の立体の見取り図をかきましょう。（うすい線はなぞりましょう。）

① 円柱

(手本)

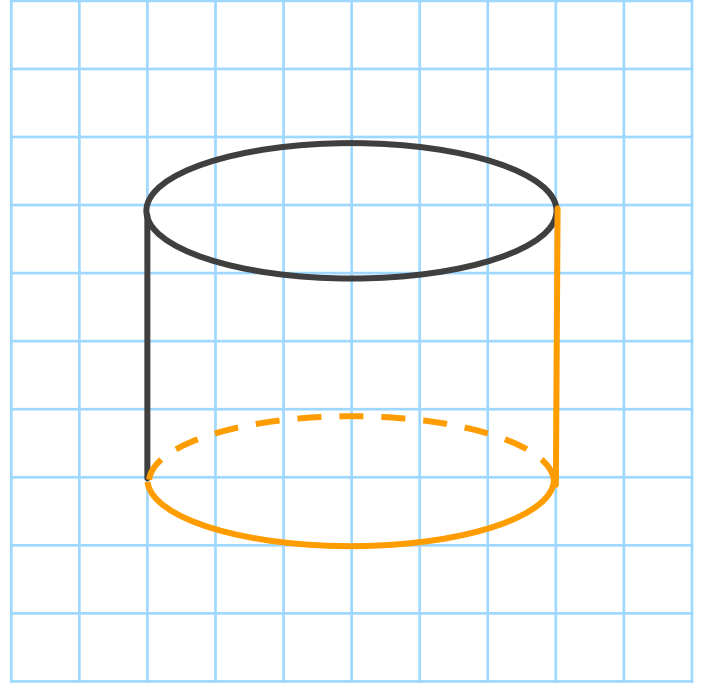
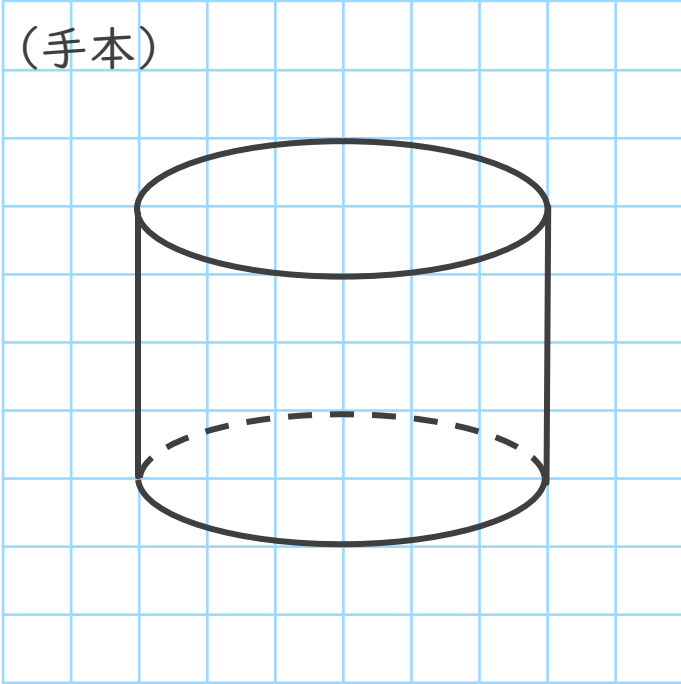

見えない辺は点線でかくよ！



② 四角柱

(手本)

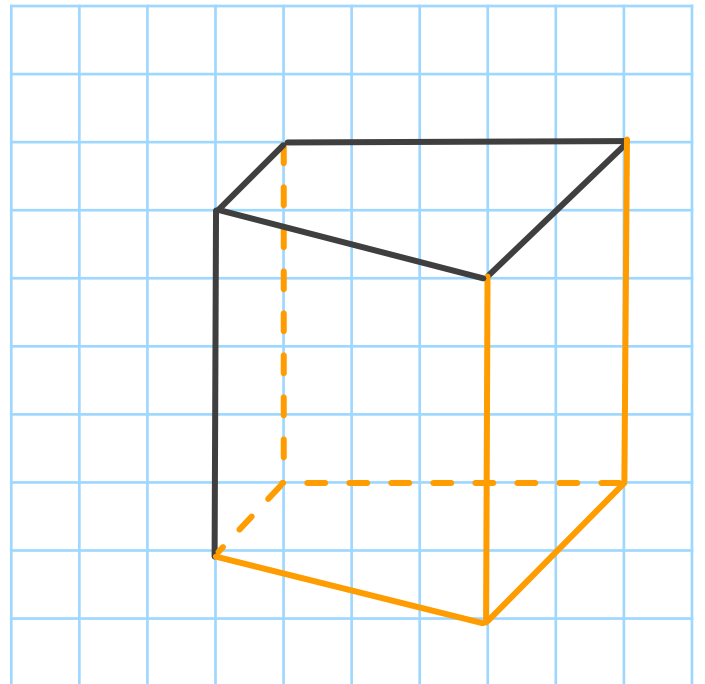
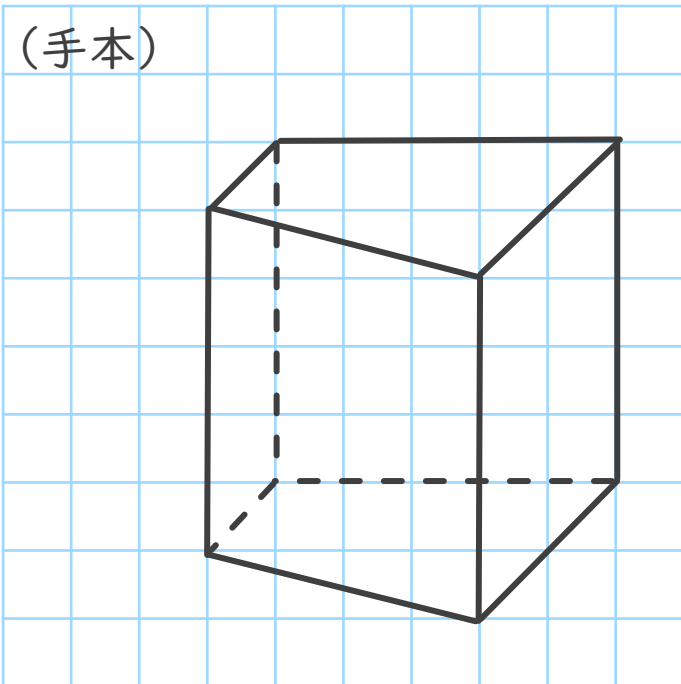



角柱と円柱 8

◎ 角柱や円柱の見取り図



日にち： 月 日

名まえ _____

・ 次の立体の見取り図をかきましょう。（うすい線はなぞりましょう。）

① 四角柱

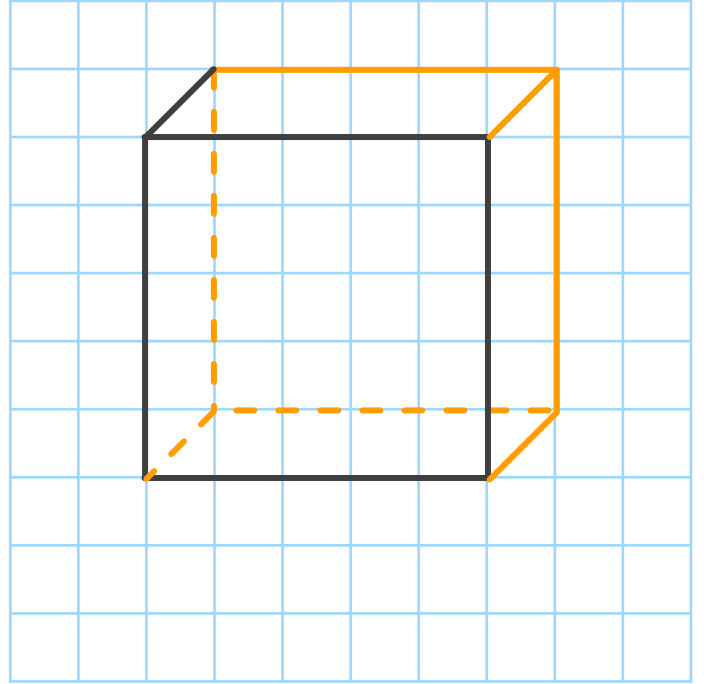
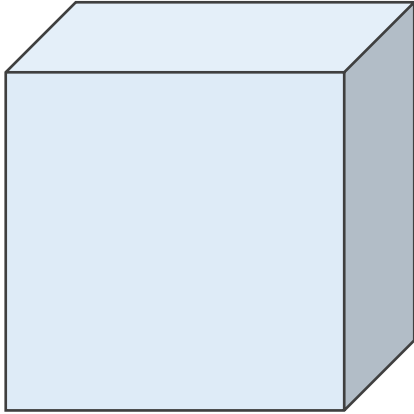

② 円柱

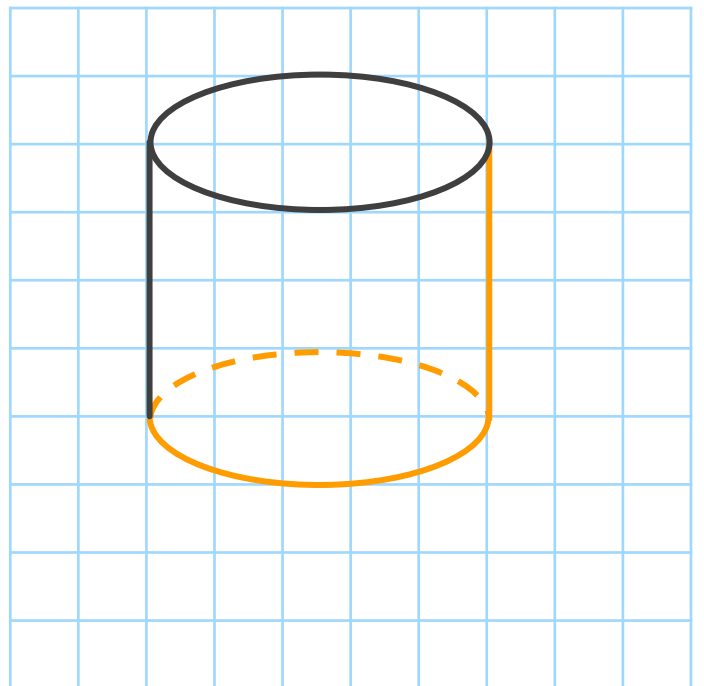
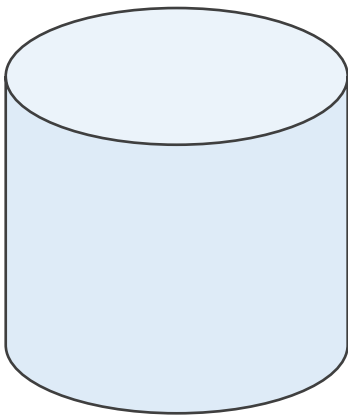



角柱と円柱 8

◎ 角柱や円柱の見取り図



日にち： 月 日

名まえ _____

・ 次の立体の見取り図をかきましょう。（うすい線はなぞりましょう。）

① 三角柱

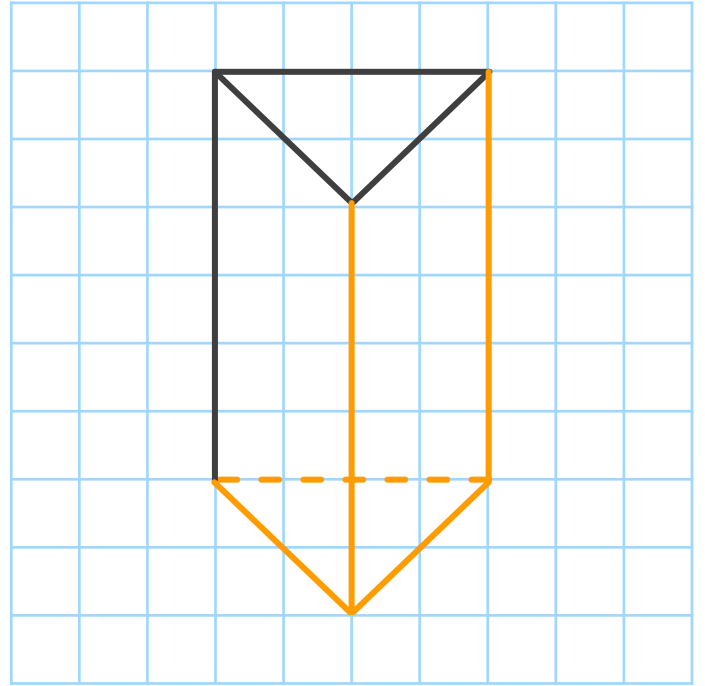
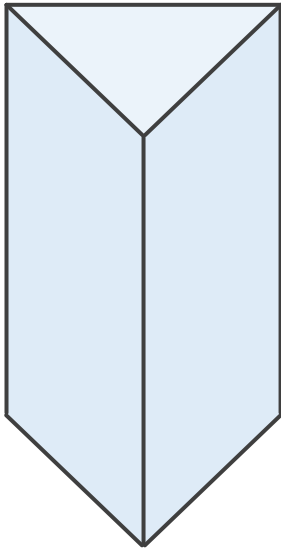

② 円柱

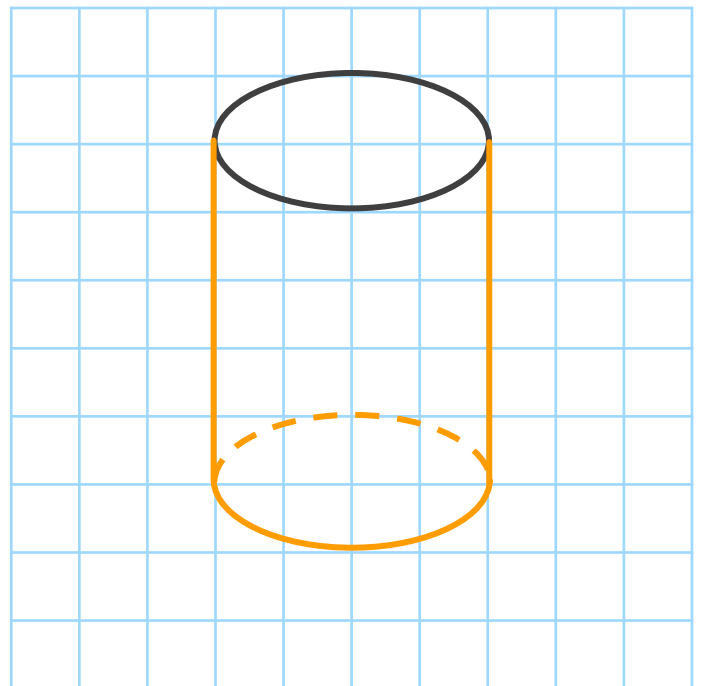
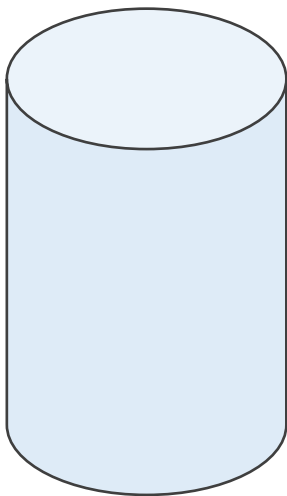



角柱と円柱 8

◎ 角柱や円柱の見取り図



日にち： 月 日

名まえ _____

・ 次の立体の見取り図をかきましょう。

① 円柱

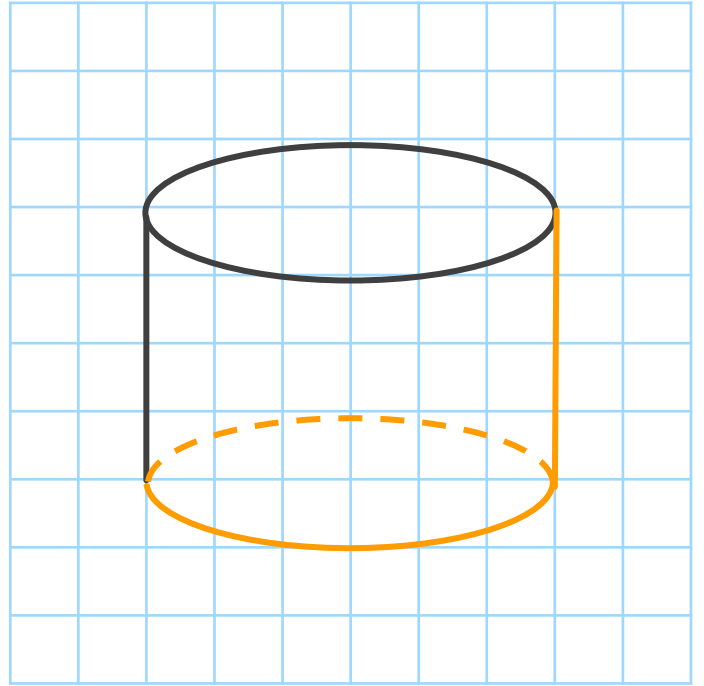
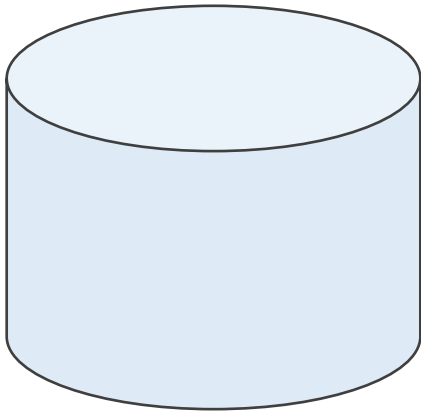

② 四角柱

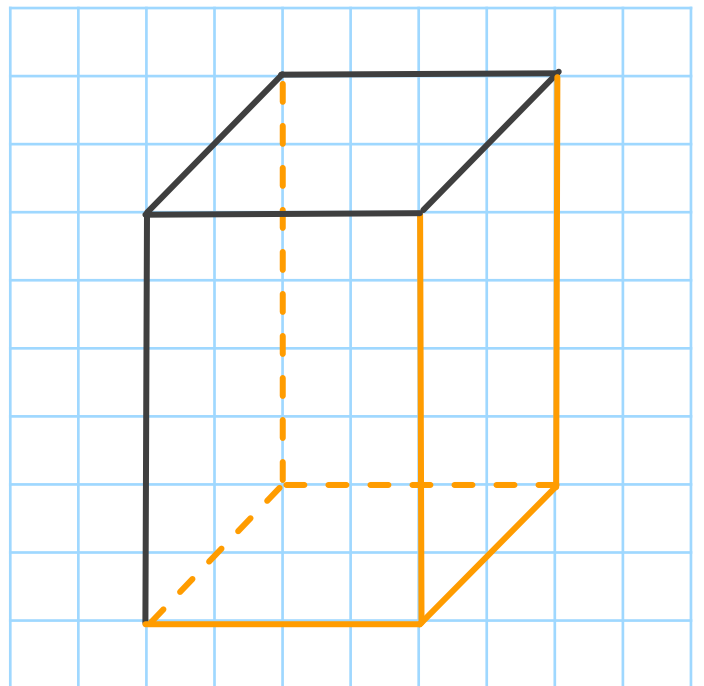
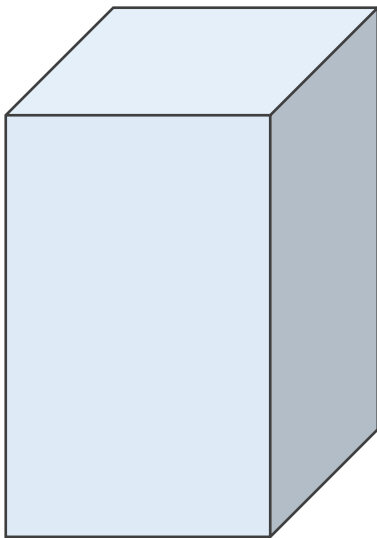



角柱と円柱 8

◎ 角柱や円柱の見取り図



日にち： 月 日

名まえ _____

・ 次の立体の見取り図をかきましょう。

① 三角柱

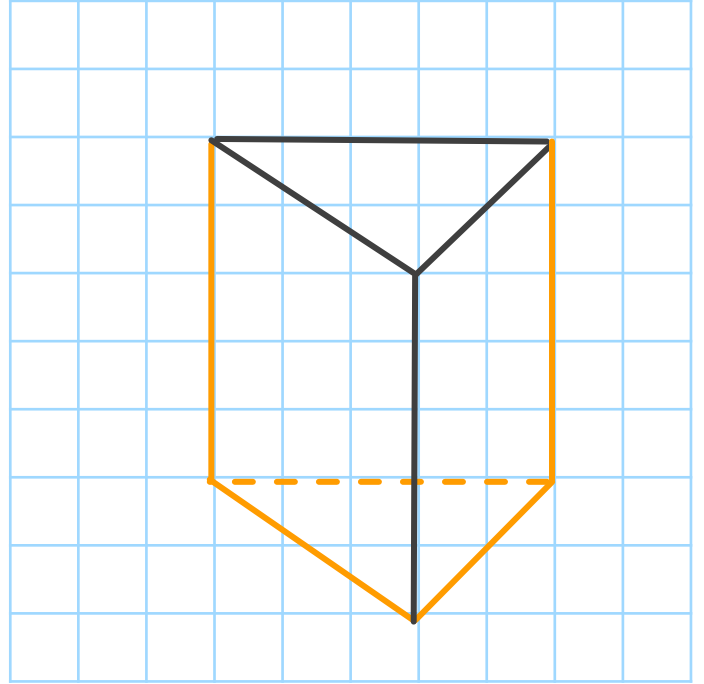
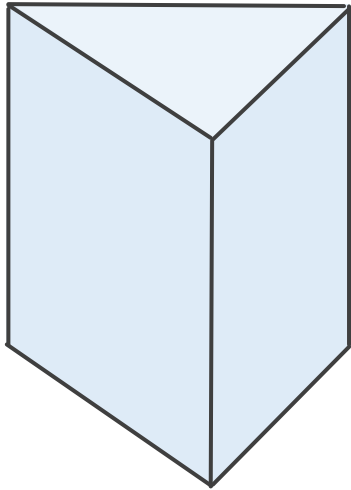

② 円柱

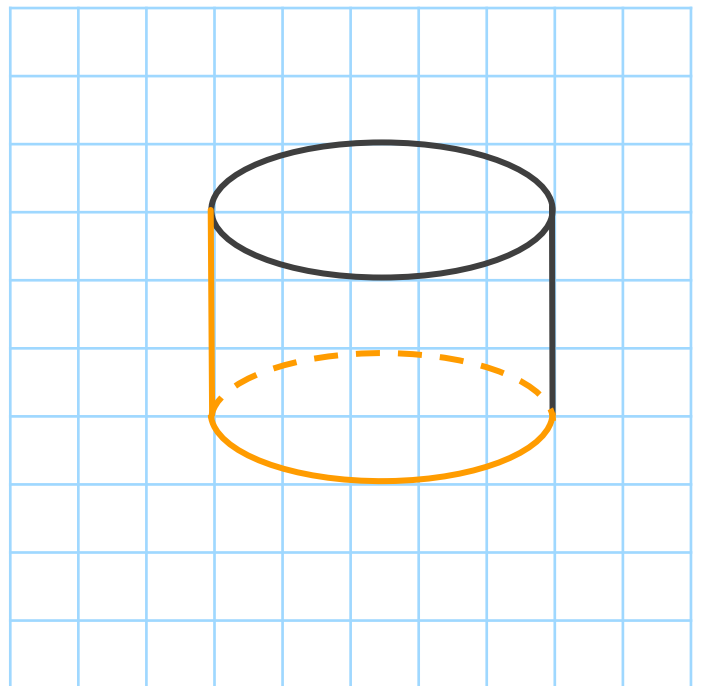
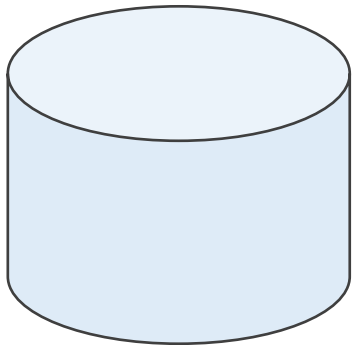



角柱と円柱 8

◎ 角柱や円柱の見取り図



日にち： 月 日

名まえ _____

・ 次の立体の見取り図をかきましょう。

① 円柱

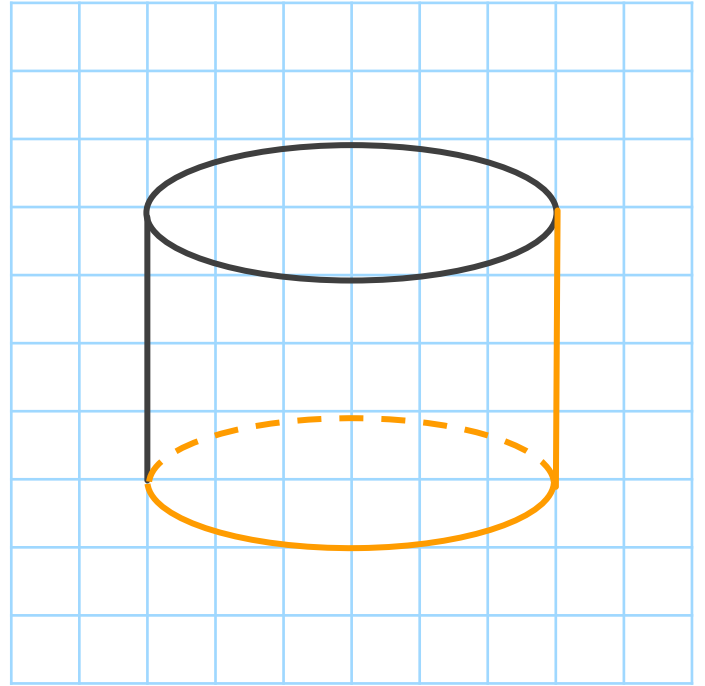
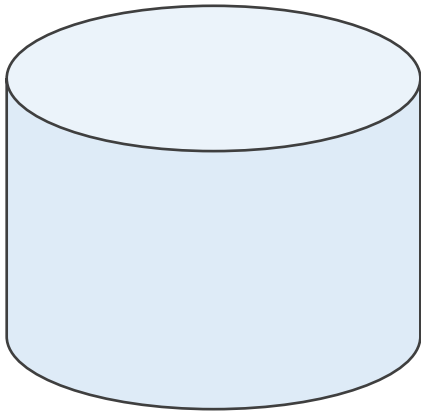

② 四角柱

