



合同な図形 7

● 合同な四角形の作図
(4組の辺と1つの角)

14

日にち： 月 日

名まえ _____

・ 下の図のような図形を、図にかかっている長さに直してかきましょう。

①

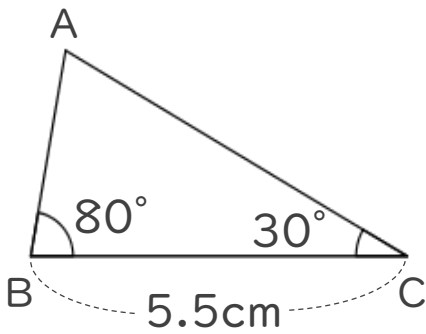

②

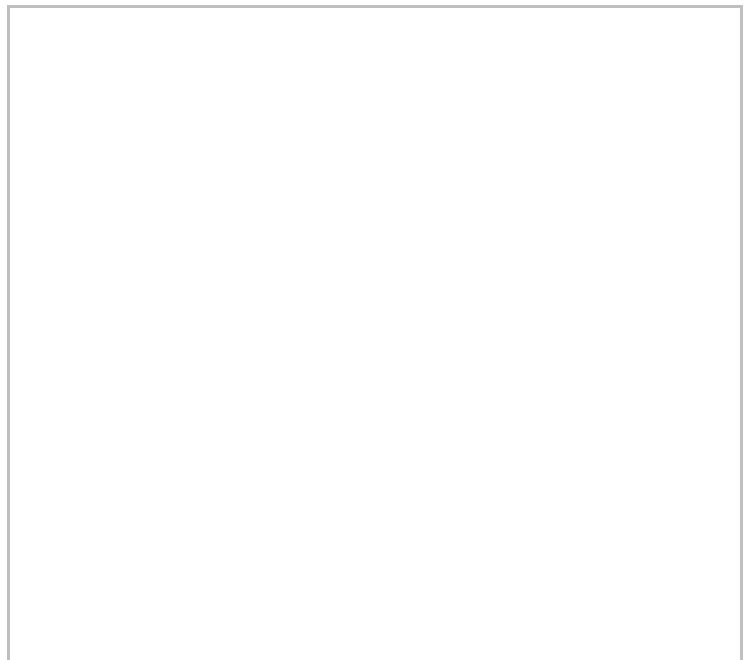
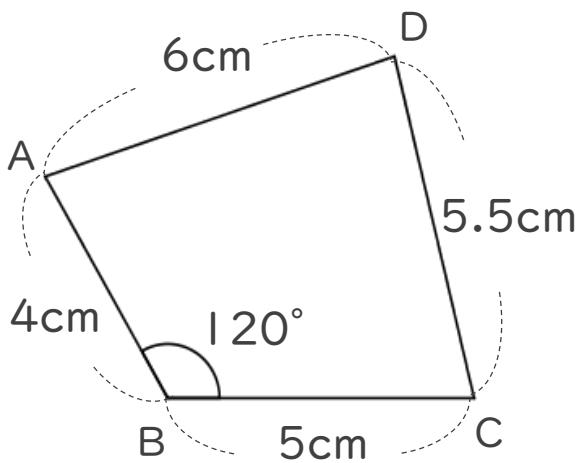



合同な図形 7

● 合同な四角形の作図
(4組の辺と1つの角)

14

日にち： 月 日

名まえ _____

・ 下の図のような図形を、図にかかっている長さに直してかきましょう。

①

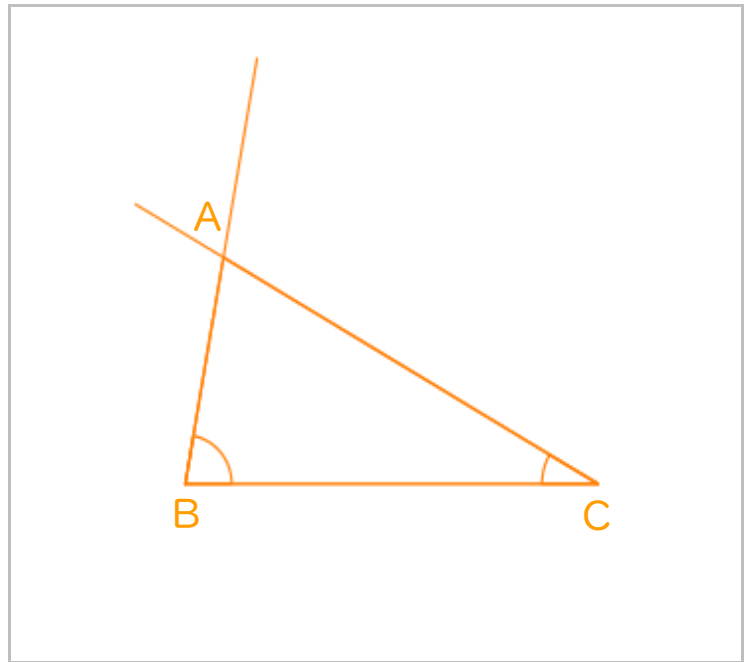
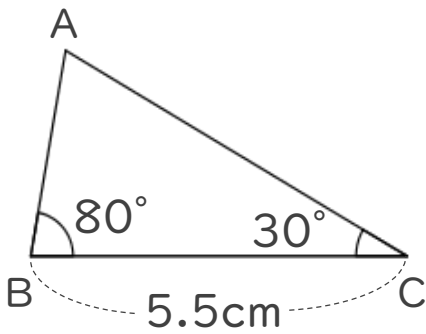

②

