



## 合同な図形 8

● 合同な四角形の作図  
(4組の辺と対角線)

15

目指せ50点!

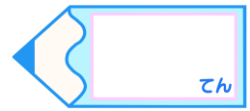

名まえ \_\_\_\_\_

・四角形ABCDを、図にかかかれている長さに直して  
かきましょう。(各50点)

①

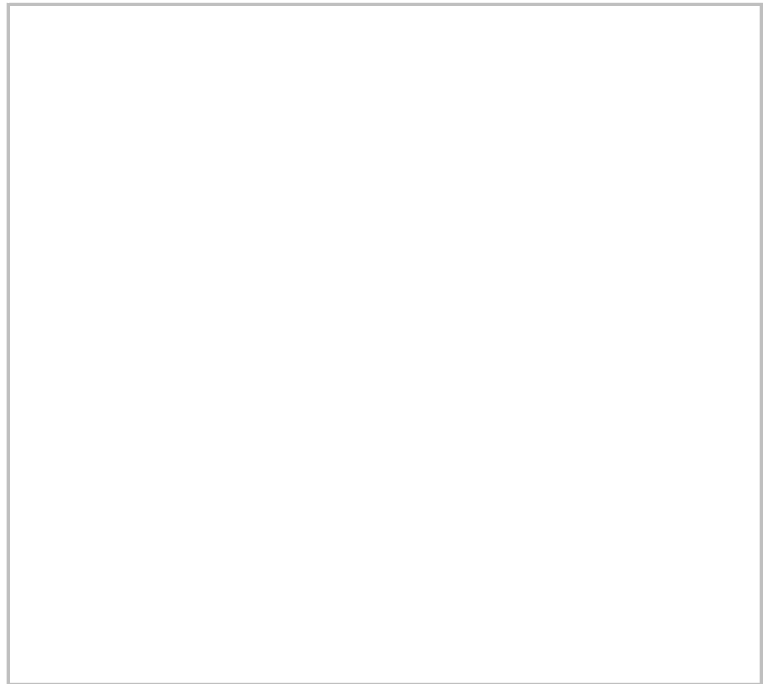
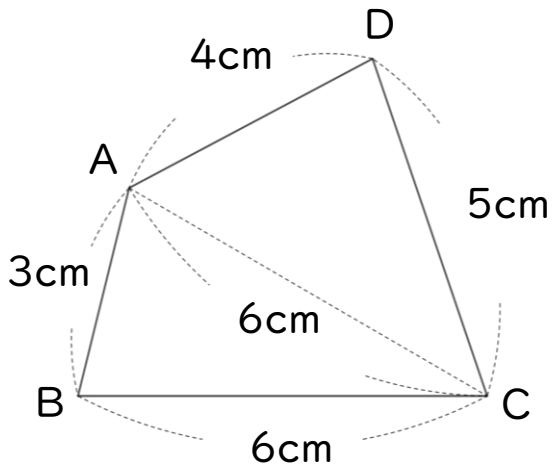

②

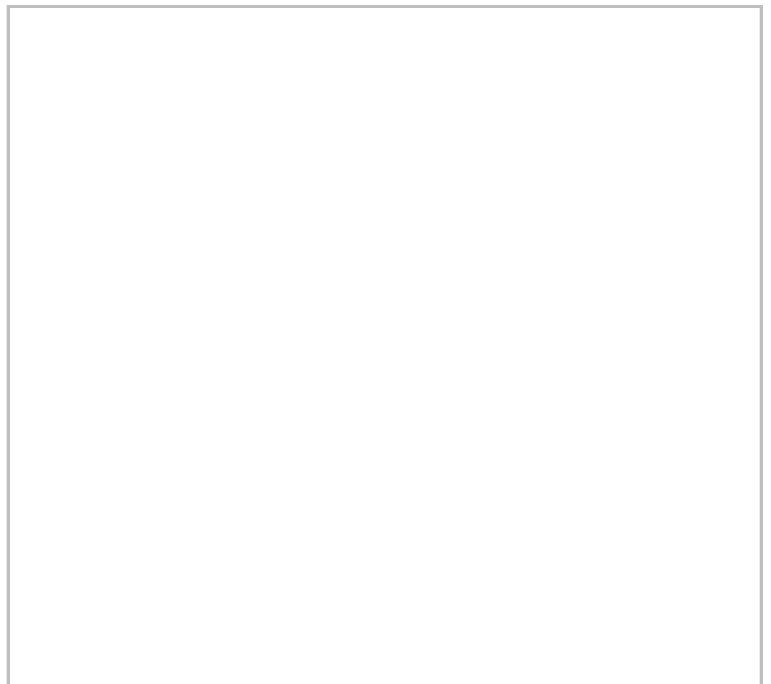
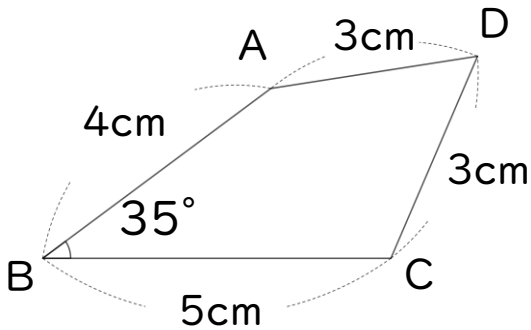



## 合同な図形 8

● 合同な四角形の作図  
(4組の辺と対角線)

15

目指せ50点!

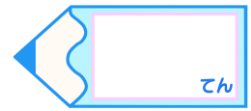

名まえ \_\_\_\_\_

・四角形ABCDを、図にかかっている長さに直して  
かきましょう。(各50点)

①

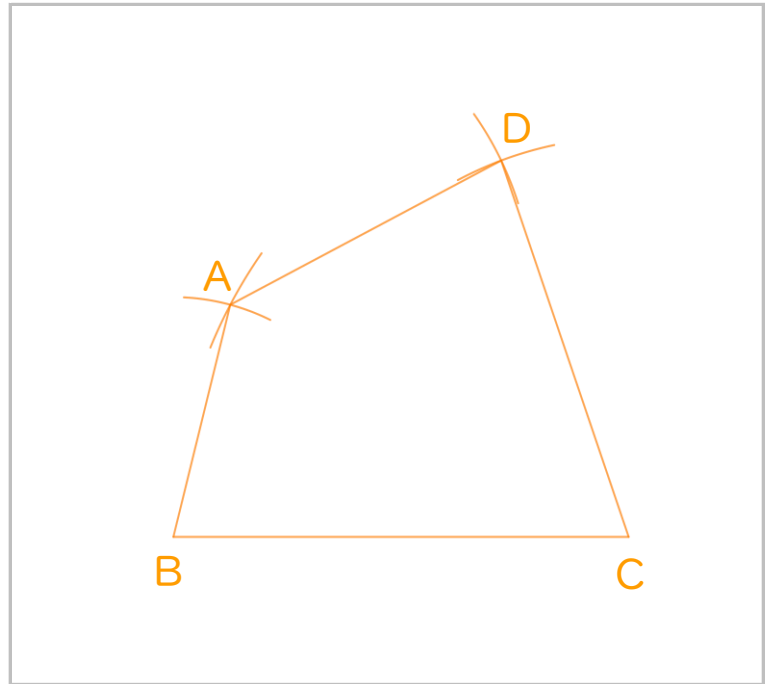
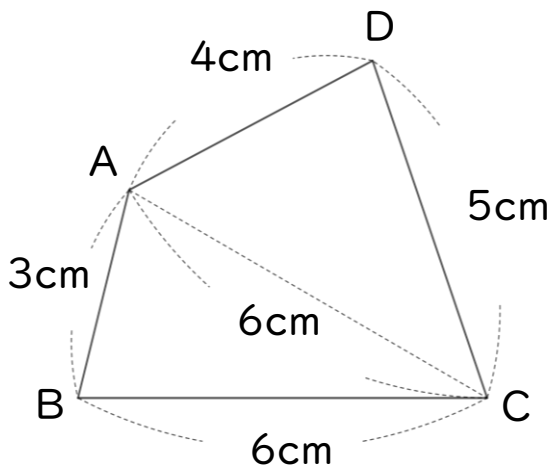

②

