



合同な図形 8

● 合同な四角形の作図
(4組の辺と対角線)

15

目指せ100点!

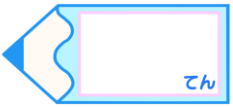

名まえ _____

・四角形ABCDを、図にかかれている長さに直して
かきましょう。(各50点)

①

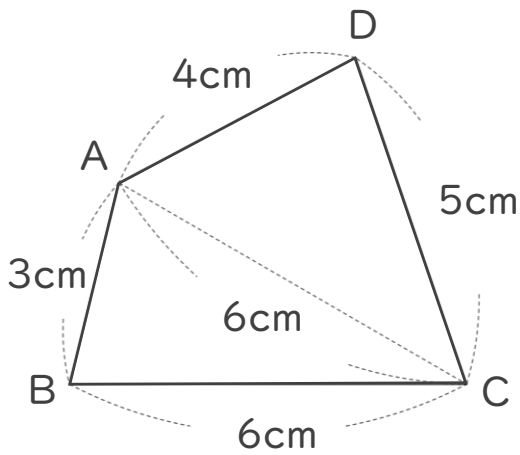

②

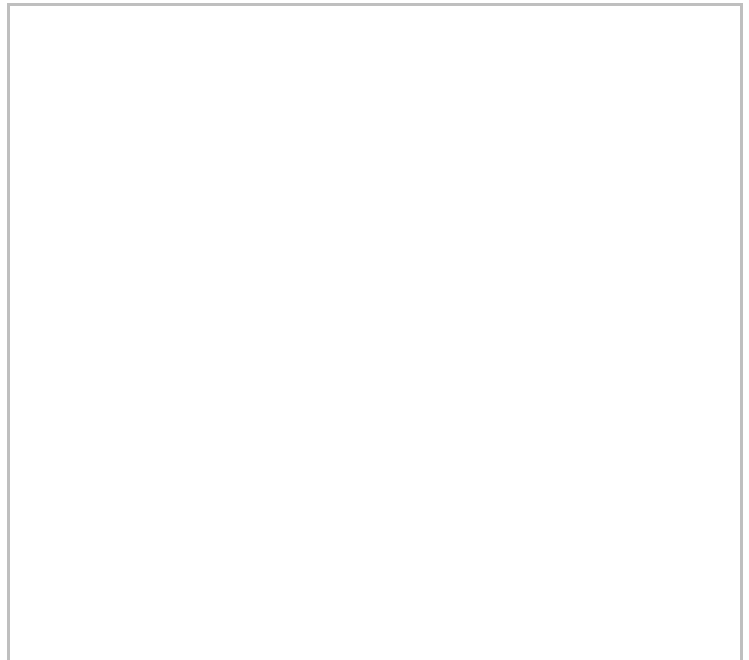
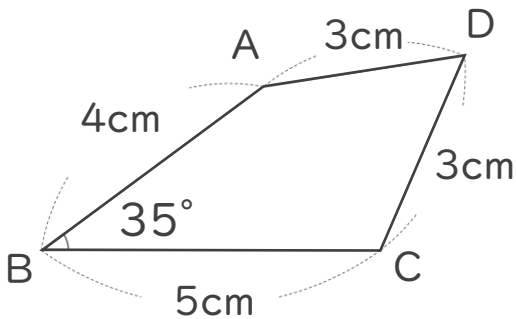



合同な図形 8

● 合同な四角形の作図
(4組の辺と対角線)

15

目指せ100点!

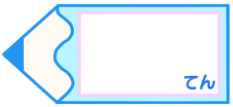

名まえ _____

・四角形ABCDを、図にかかっている長さに直してかきましょう。(各50点)

①

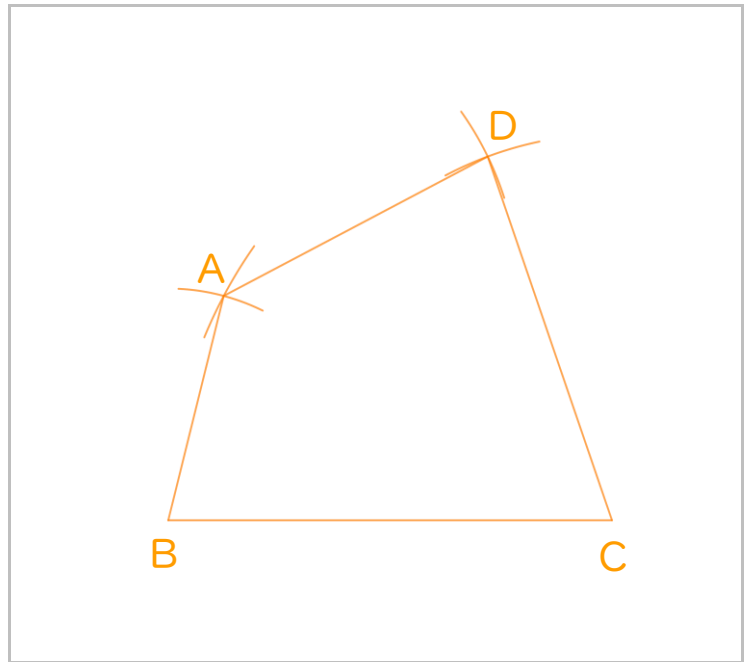
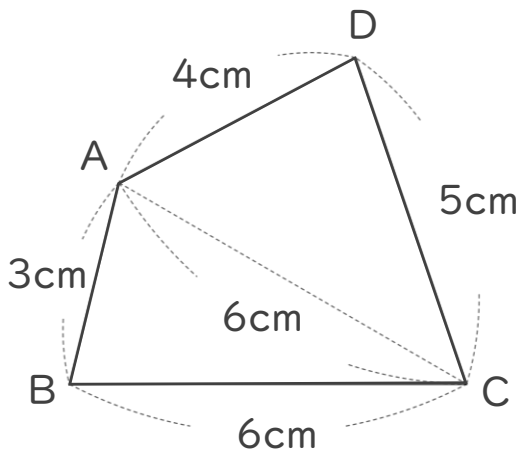

②

