



直方体や 立方体の体積 8

◎ 凸立体の体積を
引き算で求める



日にち： 月 日

名まえ _____

・ 次の立体の体積を求めましょう。

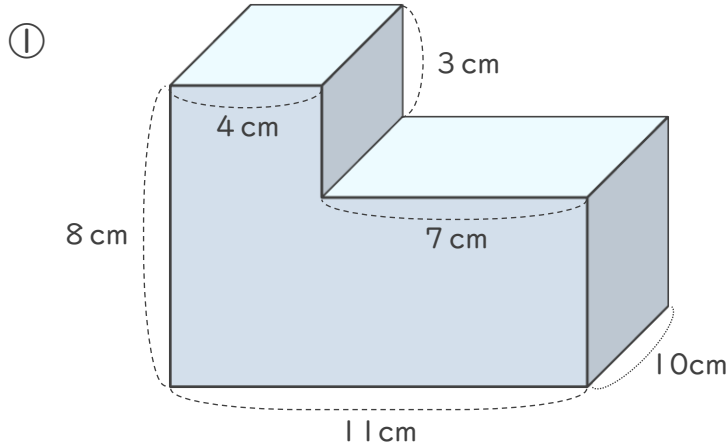

式 $10 \times 11 \times 8 = 880$

$$10 \times 7 \times 3 = 210$$

$$880 - 210 = 670$$

答え (670cm^3)

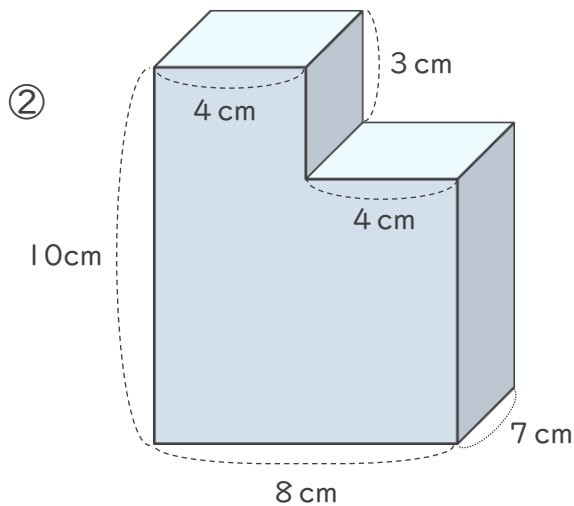

式 $7 \times 8 \times 10 = 560$

$$7 \times 4 \times 3 = 84$$

$$560 - 84 = 476$$

答え (476cm^3)

