





## 直方体や 立方体の体積 8

◎ 凸立体の体積を  
引き算で求める



日にち：            月            日

名まえ \_\_\_\_\_

・ 次の立体の体積を求めましょう。

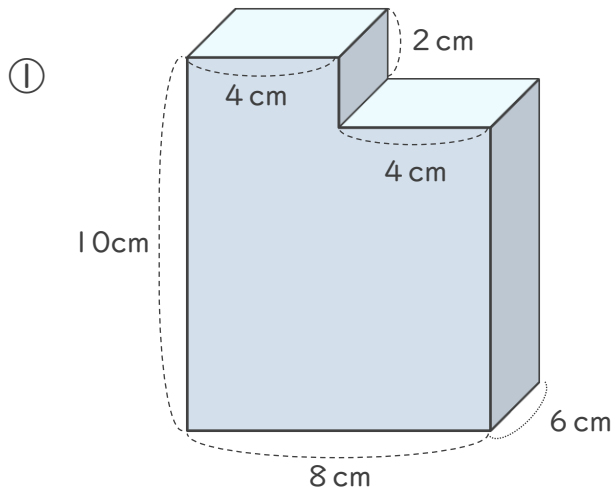

式  $6 \times 8 \times 10 = 480$

$$6 \times 4 \times 2 = 48$$

$$480 - 48 = 432$$

答え (  $432\text{cm}^3$  )

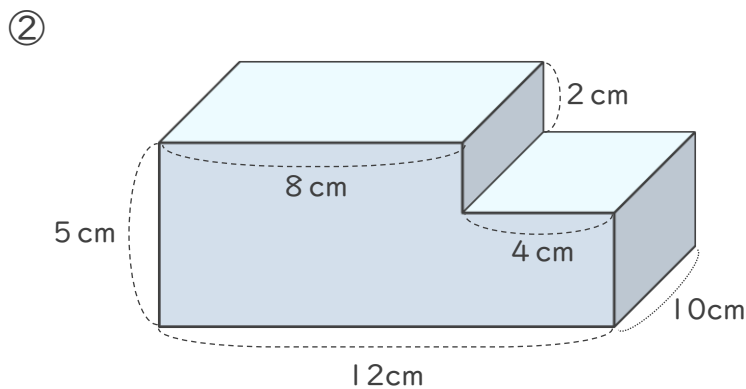

式  $10 \times 12 \times 5 = 600$

$$10 \times 4 \times 2 = 80$$

$$600 - 80 = 520$$

答え (  $520\text{cm}^3$  )

