



直方体や 立方体の体積 4

◎ 立方体の体積を求める公式



日にち： 月 日

名まえ _____

・立方体の体積を求めましょう。

①

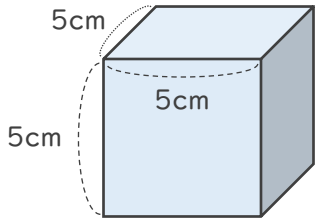

式：

答え ()

②

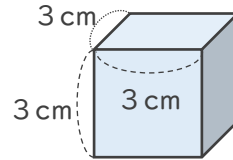

式：

答え ()

③

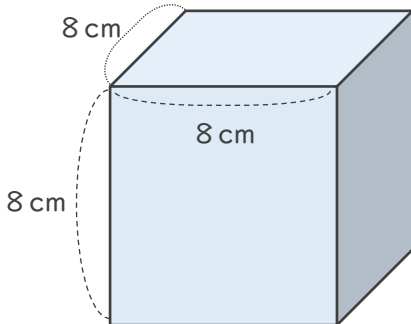

式：

答え ()

④

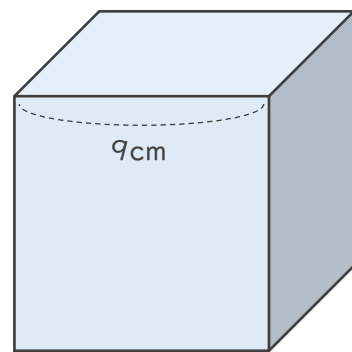

式：

答え ()





直方体や 立方体の体積 4

◎ 立方体の体積を求める公式



日にち： 月 日

名まえ _____

・立方体の体積を求めましょう。

①

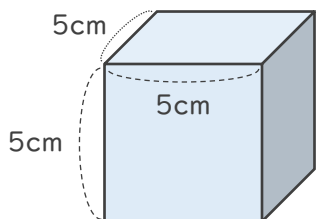

式： $5 \times 5 \times 5 = 125$

答え (125cm^3)

②

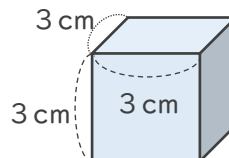

式： $3 \times 3 \times 3 = 27$

答え (27cm^3)

③

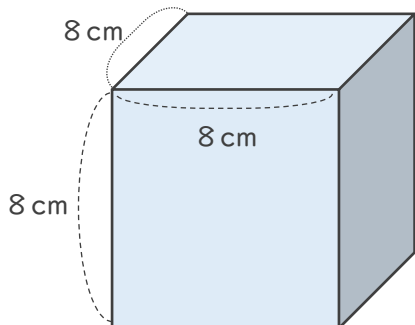

式： $8 \times 8 \times 8 = 512$

答え (512cm^3)

④

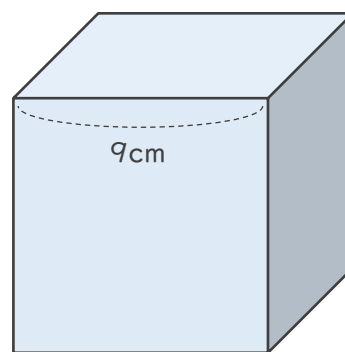

式： $9 \times 9 \times 9 = 729$

答え (729cm^3)

