



拡大図と縮図 3

● 三角形の拡大図の作図
(コンパス)



日にち： 月 日

名まえ _____

・ 次の図形の2倍の拡大図を書きましょう。

①

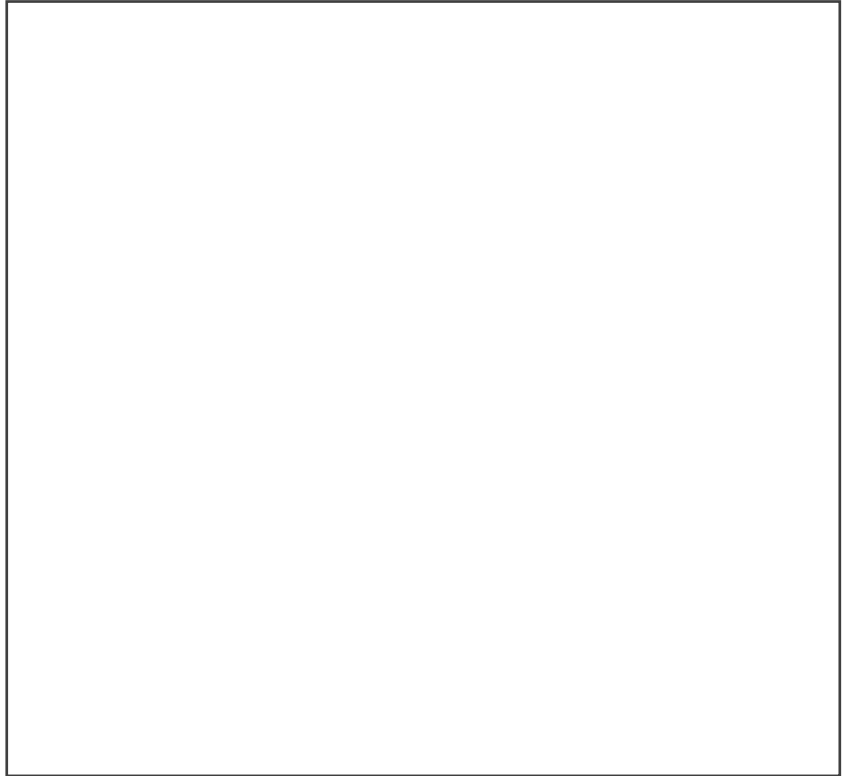
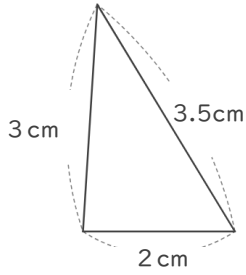

②

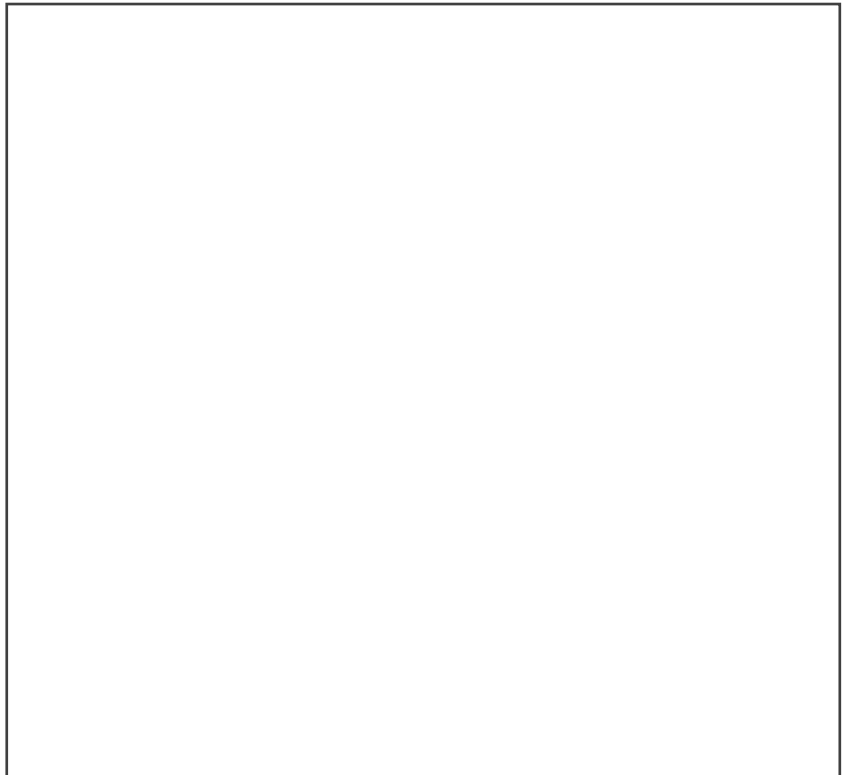
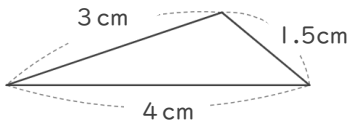



拡大図と縮図 3

● 三角形の拡大図の作図
(コンパス)



日にち： 月 日

名まえ _____

・ 次の図形の2倍の拡大図を書きましょう。

①

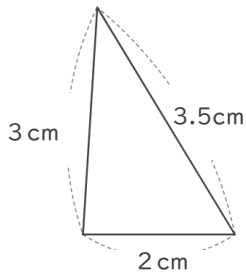

$$2\text{ cm} \times 2 = 4\text{ cm}$$

$$3\text{ cm} \times 2 = 6\text{ cm}$$

$$3.5\text{ cm} \times 2 = 7\text{ cm}$$

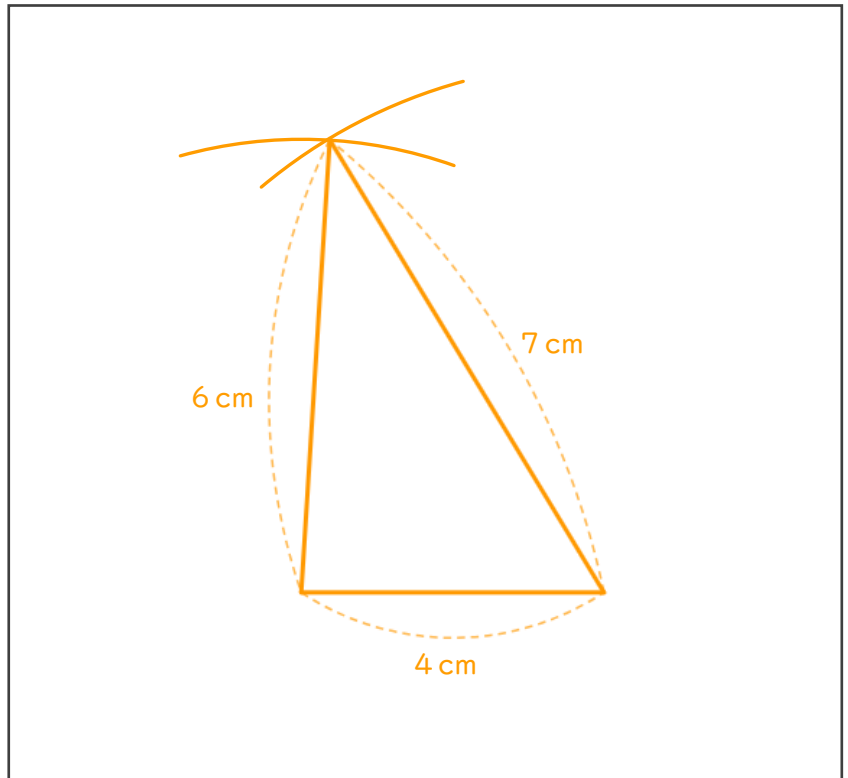

②

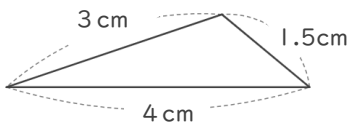

$$4\text{ cm} \times 2 = 8\text{ cm}$$

$$3\text{ cm} \times 2 = 6\text{ cm}$$

$$1.5\text{ cm} \times 2 = 3\text{ cm}$$

